

TOILETS

SERVICE PARTS BOOK

APRIL 2020



GENUINE PARTS
STERLING
A KOHLER COMPANY

KOHLER[®]
GENUINE PARTS

KOHLER® Toilets Service Parts

Tips for Finding the Right Part

Know if Your Toilet Is a One-Piece or Two-Piece Toilet



One-piece toilets integrate tank and bowl into a seamless design.



Two-piece toilets feature the traditional design of a separate tank and bowl.

Determine Your Toilet's Flushing Technology

All KOHLER flushing technologies are described, along with their common replacement parts, on pages 4–11. To determine your toilet's flushing technology, look inside the tank and compare your flushing mechanisms with those pictured in this catalog.

Look for Model and Service Information

Many toilets have service information on the underside of the tank lid.



The toilet tank number is imprinted on the inside back of the tank.

For toilet and tank K-number reference, see index on pages 12–13.

Find Your Toilet in the Matrix

If you do not find the part you need pictured on pages 4–11, use the information you have gathered to find your toilet in the corresponding section of the matrix. The replacement part numbers for the float/fill valve, flush valve, tank gasket and flush ball/flapper are listed for each toilet. To view all the service parts for your toilet, visit KOHLER.com/ServiceParts for the expanded service parts pages.

Toilets – Flushing Technologies	4–11
Index by Toilet Model Number	12–13
Toilets – Detailed Parts Matrix	

Canister (Single-Flush) One-Piece Toilets	14–17
---	-------

Canister (Single-Flush) Two-Piece Toilets.....	18–25
--	-------

Canister (Dual-Flush) One- and Two-Piece Toilets.....	26–31
---	-------

Touchless Toilets.....	32–33
------------------------	-------

2-Inch Flapper One-Piece Toilets	34–43
--	-------

2-Inch Flapper Two-Piece Toilets	44–53
--	-------

3¼-Inch Flapper One-Piece Toilets.....	54–55
--	-------

3¼-Inch Flapper Two-Piece Toilets.....	56–57
--	-------

Power Lite® One-Piece Toilets	58–59
-------------------------------------	-------

Intelligent Toilets.....	60–61
--------------------------	-------

Pressure Lite® One- and Two-Piece Toilets.....	62–63
--	-------

STERLING® Toilets	64–65
-------------------------	-------

Power Lite® One-Piece Toilets

POWER LITE®
KOHLER®

If you have a Power Lite toilet, there will be an electrical cord extending from the toilet to a power outlet.



Power Lite toilets have specific replacement parts for each model.

See pages 58–59 for parts related to Power Lite toilets.

For detailed parts listings, see pages 58–59.

Pressure Lite® One- and Two-Piece Toilets

PRESSURE LITE®
KOHLER®

If you have a Pressure Lite toilet, you will see a holding vessel within the tank.



Pressure Lite toilets have specific replacement parts for each model.

See pages 62–63 for parts related to Pressure Lite toilets.

For detailed parts listings, see pages 62–63.

Canister (Single-Flush) Toilets

CLASS SIX[®]
KOHLER.

CLASS FIVE[®]
KOHLER.

If you have a single-flush canister toilet, you will see a cylinder-shaped flush valve inside the tank instead of a flapper. The seal in the canister works similar to a flapper. ***If your toilet is leaking water into the bowl, the seal needs to be replaced, not the canister.***

AquaPiston[®]
The AquaPiston canister allows water to flow into the bowl from all sides (360 degrees), increasing the power and effectiveness of the flush.

Guide it
(Includes center guide, cap and chain)
GP1229656



YOUR CAP COLOR DOES NOT MATTER.

Match stem color and insert size.

-If stem is grey with small insert, use GP1138930.



-If stem is black with large insert, use GP1083167.



Must use proper valve for optimal performance.

Proprietary formulated yellow seal
GP1059291



Replaces red seal



Two-piece canister toilets will have triangle gasket kit or DryLock[™] gaskets.

GP51487



GP1018165-F
(3" gasket)



1024390
(bolts)



GP1112256
(2" gasket)



1024390
(bolts)



DryLock system

Canister (Dual-Flush) Toilets

DUAL FLUSH
KOHLER.

If you have a dual-flush toilet, you will see a two-button actuator on the top or a two-part trip lever on the side rather than a standard trip lever. You will see a cylinder-shaped flush valve inside the tank instead of a flapper. The seal in the canister works similar to a flapper. ***If your toilet is leaking water into the bowl, the seal needs to be replaced, not the canister.***



Flush valve seal
1131496

Flush valve seal
1270755

YOUR CAP COLOR DOES NOT MATTER.
Use GP1138930

The innovative two-tone trip lever features two flush options. The longer green lever provides a light 1.1-gallon flush; the full lever provides a full 1.6-gallon flush.



Flush valve seal
1203764



YOUR CAP COLOR DOES NOT MATTER.

Use GP1138930



Touchless Flush Toilets



KOHLER® touchless toilets offer a no-touch flush. Just hold your hand over the tank sensor to activate the flush. No handle to touch means fewer germs to pick up or leave behind.

Guide kit
(Includes center guide,
cap and chain)
GP1229656



Proprietary
formulated
yellow seal
GP1059291



Touchless unit



YOUR CAP COLOR DOES NOT MATTER.

Match stem color and insert size.

-If stem is grey with small insert,
use GP1138930.



GP1138930

-If stem is black with large insert,
use GP1083167.



GP1083167

Must use proper valve for
optimal performance.

2-Inch Flapper One-Piece Toilets

Toilets manufactured prior to 2004 most commonly have a 2-inch flapper.



**YOUR CAP COLOR
DOES NOT MATTER.**

Use GP1138930



For your toilet,
see pages 34–43.

Must use proper valve for
optimal performance.



Flappers

GP84995



Replaces flapper
with rubber bar



GP83064



GP1078440



Replaces discontinued
flappers 88925, 85655,
84138, 84314

GP89825 –
For Portrait[®] toilets



GP88921



2-Inch Flapper Two-Piece Toilets

Toilets manufactured prior to 2004 most commonly have a 2-inch flapper. All two-piece toilets that have a 2-inch flapper use fill valve GP1138930.



YOUR CAP COLOR DOES NOT MATTER.

Use GP1138930



Must use proper valve for optimal performance.

Most two-piece flapper toilets will have:

Tank gasket GP51487



Flappers

GP87449

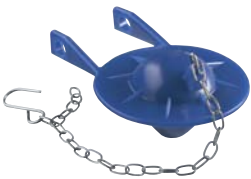

Replaces these discontinued flappers



GP85160



Replaces these discontinued flappers



GP49114



Older toilets may have a black flapper; replace with GP49114.

3¼-Inch Flapper One-Piece Toilets

CLASS FIVE.
KOHLER.

Toilets that have a 3¼-inch flapper are Class Five® toilets.
All Class Five toilets use fill valve GP1083167.



**YOUR CAP COLOR
DOES NOT MATTER.**

Fill valve
GP1083167



Must use this valve for
optimal performance.

Flappers

GP1039444 – For Cimarron®
and Memoirs®



GP1067183 – For Gabrielle™



GP1060740 – For Portrait®



3¼-Inch Flapper Two-Piece Toilets

CLASS FIVE[®]
KOHLER[®]

Toilets that have a 3¼-inch flapper are Class Five[®] toilets. All Class Five toilets use fill valve GP1083167.



Flapper

GP1078441



YOUR CAP COLOR
DOES NOT MATTER.

Fill valve
GP1083167



Must use this valve for
optimal performance.

3" DryLock™ system
gasket GP1018165-F



1024390
(bolts)



INDEX

KOHLER® Toilet Model Numbers

K-3322	34
K-3323	42
K-3324	34
K-3357	38
K-3360	38
K-3378	36
K-3379	58
K-3383	36
K-3384	42
K-3385	40
K-3386	38
K-3390	34
K-3393	58, 62
K-3394	62
K-3395	42
K-3397	42
K-3398	58
K-3400	36
K-3401	34
K-3402	38
K-3404	62
K-3405	36
K-3406	40
K-3407	50
K-3408	34
K-3410	48
K-3411	48
K-3412	48
K-3414	50
K-3415	50
K-3417	46
K-3419	46
K-3420	50
K-3421	50
K-3422	50
K-3423	50
K-3427	50
K-3428	50
K-3429	48
K-3432	50
K-3433	50
K-3434	38
K-3435	40
K-3437	58
K-3438	50
K-3439	48
K-3440	44
K-3441	50
K-3444	48
K-3445	46
K-3446	50
K-3447	46
K-3448	46
K-3449	46
K-3450	44
K-3451 (2" Flapper)	36
K-3451 (3¼" Flapper)	54
K-3452	48
K-3453 (2" Flapper)	36
K-3453 (3¼" Flapper)	54
K-3454	46
K-3455	48
K-3456	46
K-3457	46
K-3458	62
K-3461	48
K-3462	48
K-3463	46
K-3464	48
K-3465	48
K-3466	42
K-3467	42
K-3468	48
K-3470	44
K-3471	44
K-3472	44
K-3475	44
K-3477	44
K-3478	44
K-3479	44
K-3480	44
K-3481	50
K-3482	48
K-3483	48
K-3484	46
K-3485	48
K-3486	48
K-3487	56
K-3488	34
K-3489	54
K-3490	48
K-3491	48
K-3492	58
K-3493	62
K-3496 (Canister)	18
K-3496 (Flapper)	56
K-3497 (Canister)	18
K-3497 (Flapper)	56
K-3499	18
K-3500	52
K-3502	52
K-3503	56
K-3504	52
K-3505	62
K-3506	54
K-3509 (Canister)	22
K-3509 (Flapper)	56
K-3510	52
K-3511 (Canister)	22
K-3511 (Flapper)	56
K-3512	52
K-3513	54
K-3514	52
K-3515 (Canister)	22
K-3515 (Flapper)	56
K-3517	18
K-3519	62
K-3520	50
K-3521	50
K-3524	58
K-3526 (Canister)	22
K-3526 (Flapper)	56
K-3527	46
K-3530	44
K-3531	62
K-3532 (Canister)	22
K-3532 (Flapper)	56
K-3533 (Canister)	22
K-3533 (Flapper)	56
K-3535	44
K-3536	44
K-3542 (Canister)	22
K-3542 (Flapper)	56
K-3544	62
K-3546	62
K-3548 (Canister)	22
K-3548 (Flapper)	56
K-3551	18
K-3554	62
K-3555	48
K-3556	44
K-3557	44
K-3564	30
K-3574	24
K-3575	24
K-3576	24
K-3577	24
K-3588	26
K-3589	18
K-3591	48
K-3597	62
K-3598	30
K-3600	36
K-3607	58, 62
K-3608	54
K-3609	18
K-3611	24
K-3612	38
K-3615	14
K-3619	14
K-3639	14
K-3651	48
K-3652	62
K-3654	26
K-3655	34
K-3667	24
K-3668	24
K-3669	24
K-3670	34
K-3678	20
K-3713	24
K-3722	16
K-3723	28
K-3753	28
K-3754	22
K-3755	22
K-3797	28
K-3802	54
K-3803	42
K-3804	38
K-3810	16
K-3811	16
K-3812	14
K-3813	14
K-3814	20
K-3815	28
K-3816	22
K-3817	22
K-3818	20
K-3819	22
K-3825	14
K-3827	18
K-3828	14
K-3837	20
K-3851	18
K-3887	18
K-3888	18
K-3889	24
K-3900	60
K-3901	60
K-3933	22
K-3940	14
K-3946	14
K-3947	24
K-3948	24
K-3949	24
K-3950	24
K-3977	24
K-3978	24
K-3979	24
K-3981	16
K-3986	22
K-3987	30
K-3988	30
K-3989	30
K-3997	24
K-3998	24
K-3999	24
K-4000	32
K-4007	16
K-5172	16
K-5310	18
K-5692	32
K-5693	32
K-6303	30
K-6355	28
K-6418	32
K-6419	32
K-6424	16
K-6428	16
K-6669	24
K-6918	26
K-6925	14
K-6999	24
K-10491	16
K-10492	16
K-10493	22
K-10494	22
K-10495	18
K-11450	50

K-11451	18
K-11452	22
K-11453	22
K-11456	18
K-11460 (Canister)	22
K-11460 (Flapper)	56
K-11461 (Canister)	22
K-11461 (Flapper)	56
K-11465	56
K-11470	50
K-11471	24
K-11473	24
K-11492	24
K-11497	24
K-11498	24
K-11499	24
K-11813	18
K-11821	24
K-11823	18
K-11844	22
K-11889	54
K-11899	42
K-11968	22
K-12697	18
K-12698	18
K-12767	20
K-14076	50
K-14110	44
K-14128	44
K-14133	50
K-14143	50
K-14150	44
K-14178	48
K-14210	50
K-14213	44
K-14230	38
K-14239	48
K-14247	48
K-14250	44
K-14257	34
K-14258	34
K-14261	38
K-14268	34
K-14286	34
K-14289	40
K-14290	40
K-14291	40
K-14338	30
K-14343	54
K-14344	54
K-14345 (Canister)	14
K-14345 (Flapper)	54
K-14346 (Canister)	14
K-14346 (Flapper)	54
K-14509	18
K-14797	24
K-14799	24
K-14824	20
K-15410	18
K-20197	18

K-20198	18
K-20450	22
K-21285	20
K-23158	22
K-25077	22
K-25087	22
K-25097	22
K-45385	24
K-45927	24
K-45979	26
K-45989	26
K-77780	60
K-78080	16
K-90097	22
K-98864	28
K-98976	18
K-98977	18
K-98992	20
K-98993	16
K-98994	22

**KOHLER® Tank
Model Numbers**

K-3569	28
K-3613	48
K-4136	26
K-4137	26
K-4143	20
K-4166	18
K-4167	18
K-4209	50
K-4369	18
K-4383	18
K-4401	46
K-4403	46
K-4418	18
K-4419	26
K-4421	18
K-4431	18
K-4433	22
K-4434	22
K-4436	24
K-4437	24
K-4438	20
K-4441	28
K-4442	28
K-4445	48
K-4446	20
K-4447	46
K-4454	48
K-4456	44
K-4458	30
K-4464	48
K-4467	24
K-4468	24
K-4469	22
K-4470	62
K-4472	26
K-4473 (Canister)	22

K-4473 (Flapper)	56
K-4474	22
K-4484	62
K-4485 (Canister)	22
K-4485 (Flapper)	56
K-4491 (Canister)	22
K-4491 (Flapper)	56
K-4492 (Canister)	22
K-4492 (Flapper)	56
K-4493	18
K-4501	44
K-4504	50
K-4505	44
K-4509	44, 52
K-4512	50
K-4515	48
K-4516	48
K-4518	46
K-4519	50
K-4524	52
K-4586	46
K-4590	48
K-4591	44
K-4597	50
K-4605	44
K-4606	46
K-4608	48
K-4609	48
K-4619	46
K-4620	50
K-4621	50
K-4628	48
K-4632	24
K-4633	56
K-4634 (Canister)	18
K-4634 (Flapper)	56
K-4641	22
K-4642	22
K-4645	62
K-4646	50
K-4708	56
K-4742	30
K-4807	48
K-4835	18
K-4841	24
K-4899	24
K-5380	20
K-6284	30
K-7312	28
K-14078	50
K-14108	44
K-14129	44
K-14137	50
K-14147	50
K-14154	44
K-14179	48
K-14212	50
K-14215	44
K-14241	48
K-14249	48

K-14252	44
K-18829	26
K-19042	28
K-20203	18
K-20204	18
K-20205	22
K-90098	22









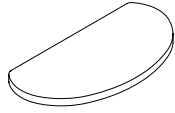
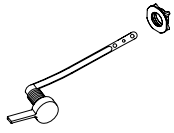

**STERLING® Toilet & Tank
Model Numbers**

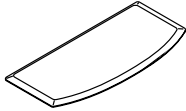
402014	64
402015	64
402020	64
402022	64
402023	64
402024	64
402025	64
402027	64
402028	64
402071	64
402075	64
402076	64
402077	64
402078	64
402079	64
402080	64
402081	64
402082	64
402083	64
402084	64
402085	64
402087	64
402088	64
402091	64
402093	64
402212	64
402213	64
402214	64
402215	64
402220	64
402315	64
402375	64
402502	64
402522	64
402532	64
403080	64
403081	64
403082	64
404514	64
404515	64
404520	64
404544	64
404551	64
404552	64
404555	64
404700	64
404701	64
404702	64
404705	64

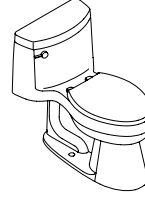
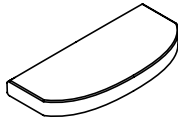
Canister (Single-Flush) One-Piece Toilets

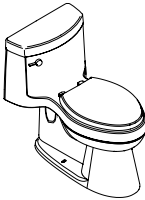
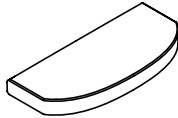

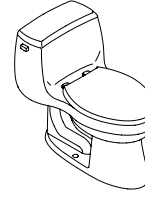
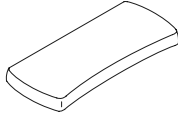
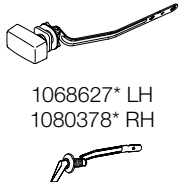
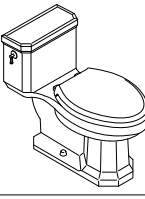
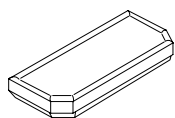

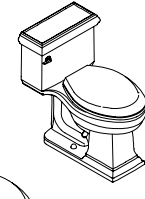
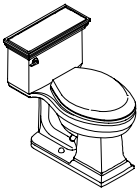
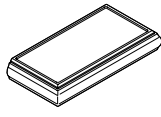
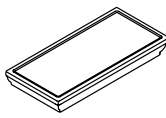
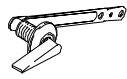
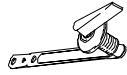







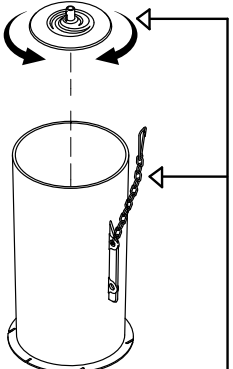

Toilet **Toilet Details**

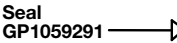
**Canister
(Single-Flush) Toilets**

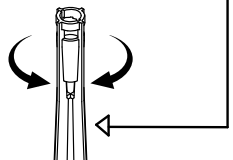
Product Name	Model Number	Tank Cover	Trip Lever
Adair® 	K-3946 K-6925	1180586* 	1034693* LH 1036058* RH 
Archer® 	K-3639	1046467* 	1067577* 
Cimarron® 	K-3828	1036367* 	1034693* LH 1036058* RH 
Cimarron With Concealed Trapway 	K-3619	1036367* 	1034693* LH 1036058* RH 
Gabrielle™ 	K-3615 K-3825 Artist Editions®: K-14345, K-14346	85407* 	1025329* LH 1025330* RH 1068627* LH 1080378* RH 
Kathryn® 	K-3940	1006066* 	1211496* LH 1264712* RH 
Memoirs® Classic   Memoirs Stately	K-3812 (Classic) K-3813 (Stately)	1220279* Classic  1220280* Stately 	1160316* LH  1160317* RH 

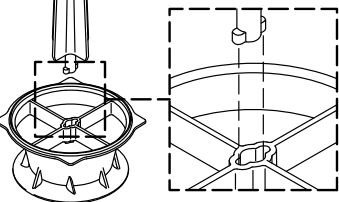
Canister (Single-Flush) One-Piece Toilets
KOHLER® Genuine Parts

Canister
 (Single-Flush) Toilets

Float/Fill Valve	Chain/Guide/Seal	Canister	Tank Gasket
GP1083167 		1218038	GP83996 
GP1083167 	<p>NOTE: The canister should not fail. If leaking occurs, replace seal GP1059291.</p>	1216616	GP83996 
GP1083167 		1216624	GP83996 
GP1083167 		1255785	GP83996 
GP1083167 		1216611	GP83996 
GP1083167 		1211498	GP83996 
GP1083167 	<p>If tabs on guide or cap break, replace with GP1229656</p>	1216612	GP83996 







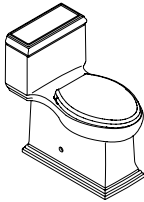
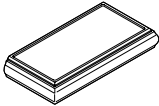
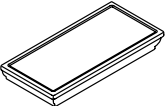
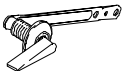

Note: Part numbers that have a "GP" prefix refer to a blister package. For example, GP1059291 is the same part as previous part number 1059291 but in a blister package.

Canister (Single-Flush) One-Piece Toilets

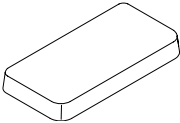
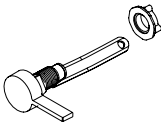
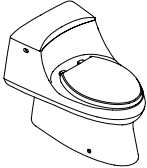
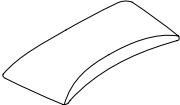
Toilet

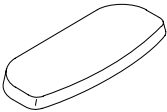

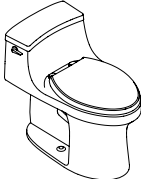
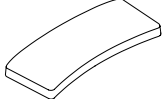
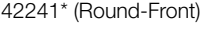

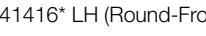
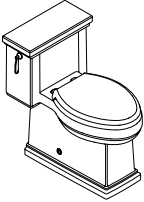
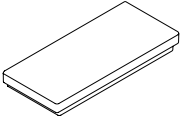
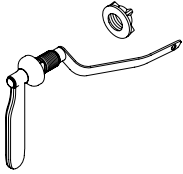







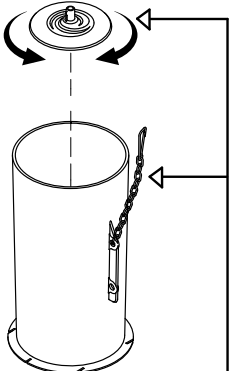

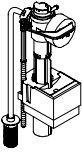
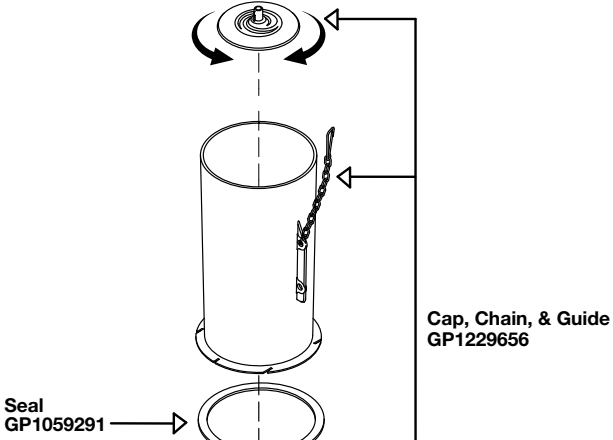
Toilet Details

Canister
(Single-Flush) Toilets

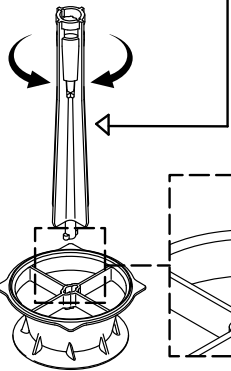
Product Name	Model Number	Tank Cover	Trip Lever
Memoirs [®] With Skirted Trapway 	K-6424 (Classic) K-6428 (Stately)	1220279* Classic  1220280* Stately 	1160316* 
Reach [®] 	K-78080	1362517* 	1402650* LH 1402651* RH 
San Raphael [®] 	K-3722	1126374* 	1128497* 
Santa Rosa [™] 	1.28 GPF K-3810 K-10491 K-98993 1.6 GPF K-3811 K-10492	88497* 	1158701* LH 1245886* RH 
San Souci [®] 	K-5172 (Elongated) K-4007 (Round-Front)	1182368* (Elongated)  1242241* (Round-Front) 	1238613* LH (Elongated) 1241200* RH (Elongated)  1241416* LH (Round-Front) 
Tresham [®] 	K-3981	1223375* 	1161319* 

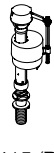
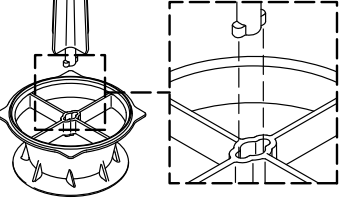
Canister (Single-Flush) One-Piece Toilets
KOHLER® Genuine Parts

Canister
 (Single-Flush) Toilets





Float/Fill Valve	Chain/Guide/Seal	Canister	Tank Gasket
GP1138930 	<p align="center">NOTE: The canister should not fail. If leaking occurs, replace seal GP1059291.</p>	1244399	GP83996 
GP1138930 		1396676	GP83996 
1128657 	 <p>Seal GP1059291 →</p> <p>Cap, Chain, & Guide GP1229656</p>	1238986 Flapper 1138648 	GP83996 
GP1083167 		1.6 GPF 1216619 1.28 GPF 1216612 1216625 (Mexico)	GP83996 
1237539 (Elongated) 		1237538 (Elongated) 1227235 (Round-Front)	GP83996 
1241415 (Round) GP1083167 	<p align="center">If tabs on guide or cap break, replace with Kit GP1229656</p>	1244399	GP83996 

Note: Part numbers that have a "GP" prefix refer to a blister package. For example, GP1059291 is the same part as previous part number 1059291 but in a blister package.

Canister (Single-Flush) Two-Piece Toilets
Toilet

Toilet Details











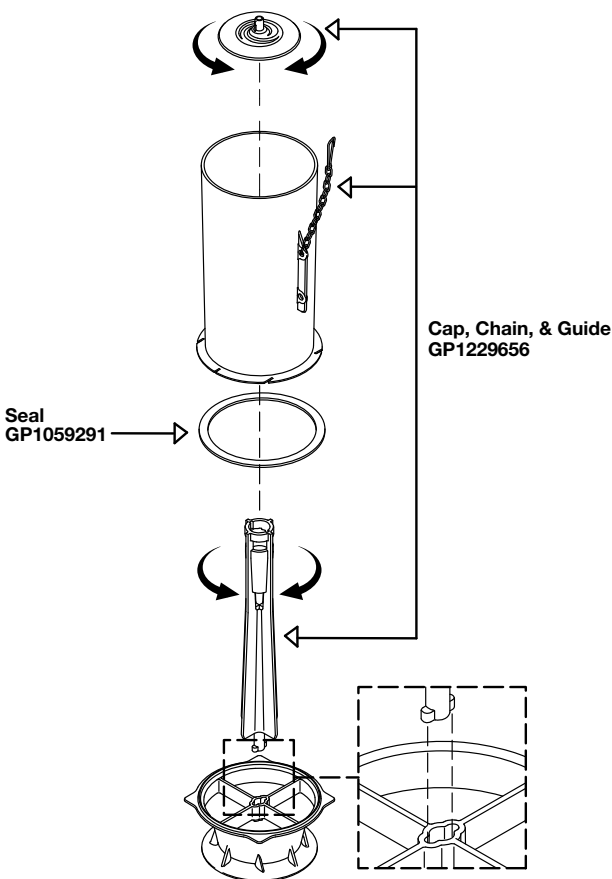



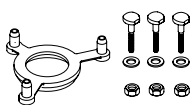

**Canister
(Single-Flush) Toilets**

Product Name	Model Number	Tank Cover	Trip Lever
Archer [®] 	1.28 GPF K-3551, K-10495 Tank: K-4431 1.6 GPF K-3517 Tank: K-4493	1046467* 	1067577* 
Bancroft [®] 	K-3827 Tank: K-4383	1033723* 	1042212* 
Betello [®] 	K-20197 Tank: K-20203 K-20198 Tank: K-20204	1378750* 	1378311* LH 1378310* RH 
Cavata [®] 	K-12697 K-12698 Tank: K-4835	1145294* 	1154764* 
Cimarron [®] 	Elongated 1.28 GPF K-3609, K-11451, K-11813, K-98977 Tank: K-4421 1.6 GPF K-3589, K-11456, K-11823 Tank: K-4418	1086929* 	1034693* LH 1116014* RH 
	Round-Front 1.28 GPF K-3851, K-3887, K-14509, K-15410, K-98976 Tank: K-4166 1.6 GPF K-3888 Tank: K-4167		
	Elongated 1.28 GPF K-3496-HE, K-3496, K-3497, K-3499 Tank: K-4634-HE, K-4634		
Cimarron With Skirted Trapway 	K-5310 Tank: K-4369	1086929* 	1034693* LH 1116014* RH 

Canister (Single-Flush) Two-Piece Toilets

KOHLER® Genuine Parts

Canister
(Single-Flush) Toilets

Float/Fill Valve	Chain/Guide/Seal	Canister	Tank Gasket
GP1083167 	<p>NOTE: The canister should not fail. If leaking occurs, replace seal GP1059291.</p>  <p style="text-align: center;">Cap, Chain, & Guide GP1229656</p> <p style="text-align: center;">Seal GP1059291</p> <p style="text-align: center;">If tabs on guide or cap break, replace with GP1229656</p>	1.28 GPF 1216613 1216621 (Mexico)	GP1018165-F  1024390 
GP1083167 		1216614	GP51487 
GP1083167 		1378304 1309116	GP1112256  1324795
GP1083167 		1161447	GP51487 
GP1083167 		1.28 GPF 1.6 GPF 1188999 1188998 1190386 (Lined Tank)	GP1112256  1024390 
GP1138930 		1.28 GPF 1.6 GPF 1189000 1189001 1191371 (Lined Tank)	1.28 GPF 1059288 (HE) 1083980
GP1138930 		1188998	GP1112256  1024390 

Note: Part numbers that have a "GP" prefix refer to a blister package. For example, GP1059291 is the same part as previous part number 1059291 but in a blister package.

Canister (Single-Flush) Two-Piece Toilets















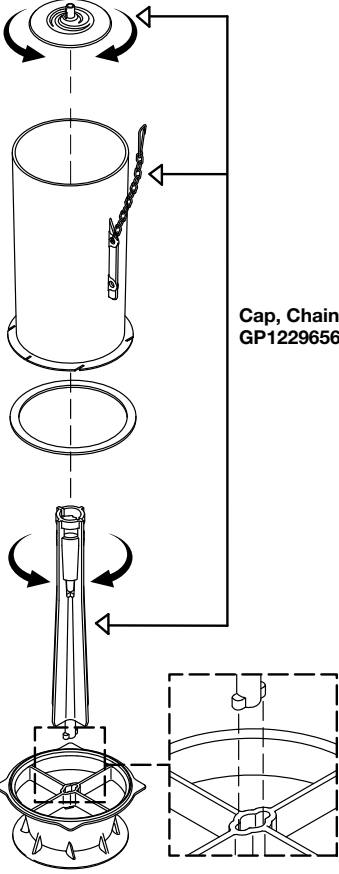



Toilet Details

Canister
(Single-Flush) Toilets

Product Name	Model Number	Tank Cover	Trip Lever
Corbelle® With Skirted Trapway 	K-3814 Tank: K-4143	1306245* 	1292297* LH 1292860* RH 
Devonshire® 	1.28 GPF K-3837, K-14824, K-98992 Tank: K-4438	1044820* 	1160316* LH 1160317* RH 
	1.28 GPF K-3678 Tank: K-4446		
Elliston® 	K-12767 Tank: K-5380	1211811* 	1213839* 
Elmbrook™ 	K-45983, K-21285 Complete Solution	1282458* 	1288036* 
Highline® 	K-5298 Tank: K-5308	1138565* 	1142713* 
Highline Classic 	K-5299 Tank: K-5307	84591* 	1117207* LH 1133133* RH 
Highline With Concealed Trapway 	K-76301 Tank: K-5311	1138565* 	1142713* 

Canister (Single-Flush) Two-Piece Toilets
 KOHLER® Genuine Parts

Canister
 (Single-Flush) Toilets

Float/Fill Valve	Chain/Guide/Seal	Canister	Tank Gasket
GP1138930 		1309116	GP1112256  1324795
GP1083167 	<p>NOTE: The canister should not fail. If leaking occurs, replace seal GP1059291.</p>	1216615	GP51487 
GP1083167 	 <p>Cap, Chain, & Guide GP1229656</p>	1126916	GP1018165-F  1024390 
GP1083167 	<p>Seal GP1059291 →</p>	1216610 1288037	GP1018165-F GP1018165  1024390 
GP1083167 		1288037	GP1018165  1024390 
GP1083167 	<p>If tabs on guide or cap break, replace with GP1229656</p>	1294218	GP51487 
GP1138930 		1294217	GP51487 
GP1138930 		1294219	GP51487 



Note: Part numbers that have a "GP" prefix refer to a blister package.
 For example, GP1059291 is the same part as previous part number 1059291 but in a blister package.

Canister (Single-Flush) Two-Piece Toilets

Toilet

Toilet Details

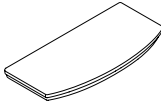









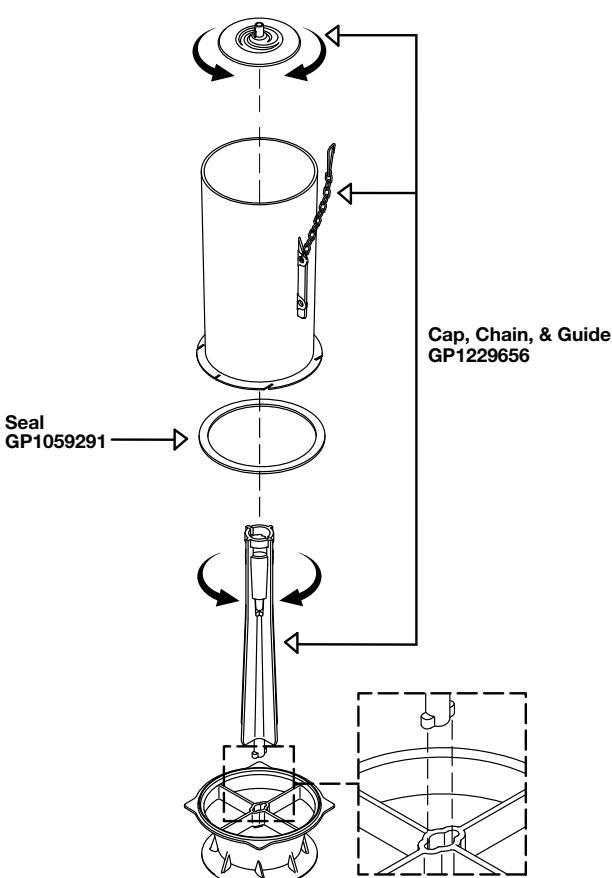



Canister (Single-Flush) Toilets

Product Name	Model Number	Tank Cover	Trip Lever
Irvine® 	K-20450 Tank: K-20205 K-90097 Tank: K-90098	1378749* 	1378314* LH 1378313* RH 
Kelston® 	1.28 GPF K-11453, K-11844, K-3755 Tank: K-4469 1.6 GPF K-3754, K-11452 Tank: K-4474	1070414* 	1075394* 
Kingston™ 	K-25077, K-25087, K-25097 Tank: K-25100	1324740* 	1334685* LH 1321449* RH 
Lintelle® 	K-23158	1346865* 	1075394* 
Memoirs® Classic 	1.28 GPF K-3986, K-3816, K-10493 Tank: K-4433 1.6 GPF K-3818 Tank: K-4641 K-11461, K-3509, K-3515 Tank: K-4491 K-3532, K-3542 Tank: K-4485 (Lined)	1052861* Classic 	1160316* LH 1160317* RH 
Memoirs Stately 	1.28 GPF K-3933, K-3817, K-10494, K-98994 Tank: K-4434 1.6 GPF K-3819 Tank: K-4642 K-3511, K-3526, K-11460 Tank: K-4492 K-3533, K-3548, K-11968 Tank: K-4473 (Lined Tank)	1052862* Stately 	1160316* LH 1160317* RH 

Canister (Single-Flush) Two-Piece Toilets

KOHLER® Genuine Parts

Canister
(Single-Flush) Toilets

Float/Fill Valve	Chain/Guide/Seal	Canister	Tank Gasket
GP1083167 	<p>NOTE: The canister should not fail. If leaking occurs, replace seal GP1059291.</p> 	1378305	GP1112258  1234795
GP1083167 		<p>1.28 GPF 1216610</p> <p>1.6 GPF 1216609</p>	GP1018165-F 
GP1083167 		1364774	GP51487 
GP1083167 		1288037	GP1018165-F  1024390 
GP1083167 		<p>1.28 GPF 1116617 1216622 (Lined Tank)</p> <p>1.6 GPF 1152861 (Lined Tank) 1216620 (K-4641) 1080961 (K-4491)</p>	<p>1.28 GPF GP51487 </p> <hr/> <p>1.6 GPF GP1018165-F  1024390 </p>
GP1083167 		<p>If tabs on guide or cap break, replace with GP1229656</p>	<p>1.28 GPF 1116617 1216622 (Lined Tank)</p> <p>1.6 GPF 1152861 (Lined Tank) 1216620 (K-4642) 1080961 (K-4492)</p>











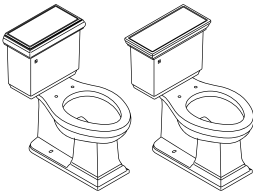
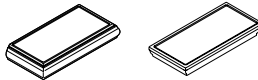

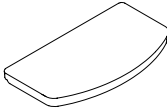

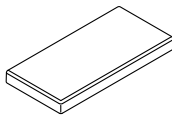

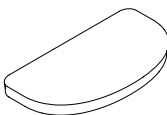

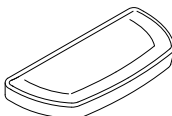
Note: Part numbers that have a "GP" prefix refer to a blister package.
For example, GP1059291 is the same part as previous part number 1059291 but in a blister package.

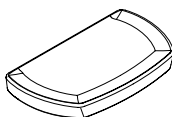
Canister (Single-Flush) Two-Piece Toilets

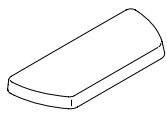
Toilet

Toilet Details

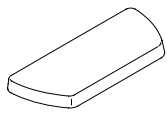









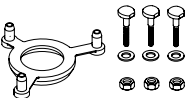

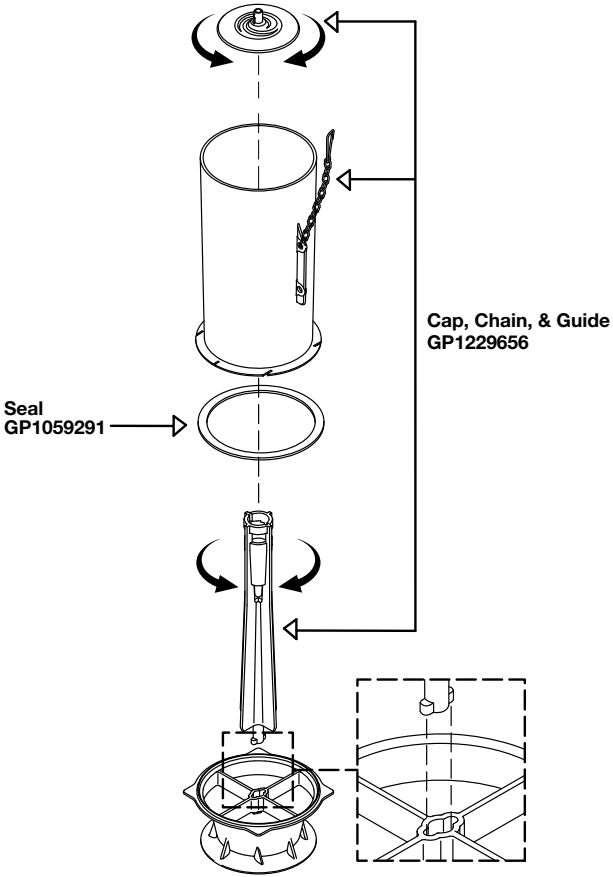

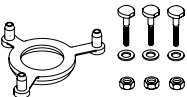
Canister (Single-Flush) Toilets

Product Name	Model Number	Tank Cover	Trip Lever
Memoirs With Concealed Trapway 	Classic K-6999 Tank: K-4433 Stately K-6669 Tank: K-4434	1052861* Classic 1052862* Stately 	1160316* LH 1160317* RH 
Transpose® 	K-45385	1301456* 	1293931* 
Tresham® 	K-3950 Tank: K-4899	1146775* 	1161319* 
Valiant® 	K-45927	1366354* 	1292867* 
Wellworth®, Highline® 	1.28 GPF K-3997, K-3998, K-3999, K-3889, K-5481 Tank: K-4467 1.6 GPF K-3977, K-3978, K-3979 Tank: K-4468	1138565* 	1142713* 
Wellworth, Highline 	K-3947, K-3948, K-3949 Tank: K-4841	1145223* 	1142713* 
Wellworth Classic, Highline Classic 	1.28 GPF K-3658, K-3713 Tank: K-4436 1.6 GPF K-11821, K-11471, K-11473, K-11492, K-3574, K-3576, K-3611 Tank: K-4632	84591* 84095* (14" Tank) 	1117207* LH (Metal Arm) 1069723* LH (Plastic Arm)  1133133* RH (Metal Arm) 
Wellworth Classic 	1.28 GPF K-3575, K-3577, K-11497, K-11498, K-11499, K-14797, K-14799, K-11464, K-76407, K-5296, K-17068 Tank: K-4436 1.6 GPF K-3667, K-3668, K-3669 Tank: K-4437	84591* 84095* (14" Tank) 	1117207* LH (Metal Arm)  1133133* RH (Metal Arm) 

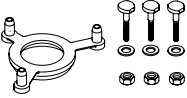
Canister (Single-Flush) Two-Piece Toilets

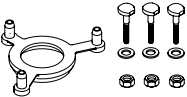
KOHLER® Genuine Parts

Canister
(Single-Flush) Toilets

Float/Fill Valve	Chain/Guide/Seal	Canister	Tank Gasket
GP1083167 		1216617	GP51487 
GP1138930 	<p>NOTE: The canister should not fail. If leaking occurs, replace seal GP1059291.</p>  <p>Seal GP1059291</p> <p>Cap, Chain, & Guide GP1229656</p> <p>If tabs on guide or cap break, replace with GP1229656</p>	1309116	GP1112256  1324795
GP1083167 		1216618	GP51487 
GP1138930 		1309117	GP1112256  1324795
GP1083167 		<p>1.28 GPF 1142714 115553 (Lined Tank)</p> <p>1.6 GPF 1145365</p>	GP51487 
GP1083167 		<p>1151862 1160809 (Lined Tank)</p>	GP51487 
GP1083167 		<p>1.28 GPF 1117210</p> <p>1.6 GPF 1069722 (Plastic Arm)</p>	GP51487  GP1018165-F 1024390
GP1083167 		<p>1.28 gpf 1117210 1130564 (Lined Tank)</p> <p>1.6 gpf 1158795 1158796 (Lined Tank)</p>	GP51487 

Note: Part numbers that have a "GP" prefix refer to a blister package. For example, GP1059291 is the same part as previous part number 1059291 but in a blister package.







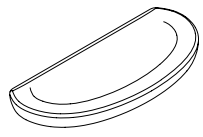
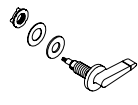
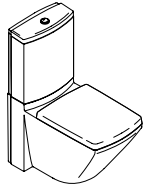
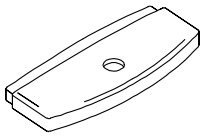
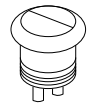
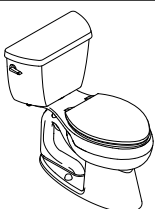
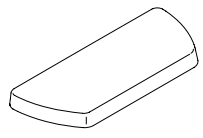
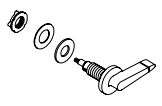
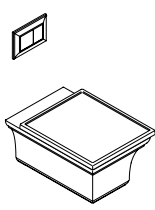
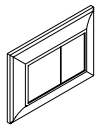
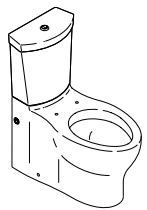
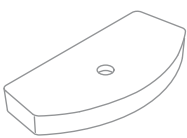
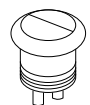
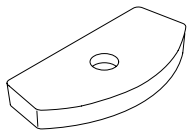
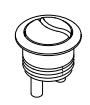



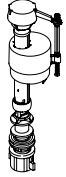



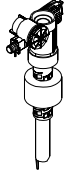
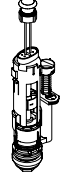

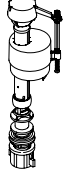
Canister (Dual-Flush) One- and Two-Piece Toilets
Toilet

Toilet Details

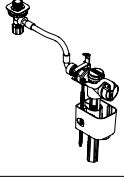
Canister
(Dual-Flush) Toilets

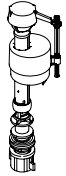
Product Name	Model Number	Tank Cover	Trip Lever/Flush Actuator
Cavata® 	K-45989 Tank: K-4137	1145294* 	1203699* 
Escala® 	K-3588 Tank: K-4472	1045184* 	1266856* 
Highline® 	K-45979 Tank: K-4136	84591* 	1208884* 
Memoirs® 	K-6918 In-Wall Tank: K-18829	N/A	K-77271 
Persuade® 	K-3654 Tank: K-4419	Discontinued; Service With 1260938* & 1265519* 	1266856*  For use with 1 1/16" hole
		1260938* 	1265519*  For use with 2" hole

Canister (Dual-Flush) One- and Two-Piece Toilets
 KOHLER® Genuine Parts

Float/Fill Valve	Flush Valve	Tank Gasket	Canister Seal
GP1083167 	1203698 	GP51487 	1203764 
1246185 	1095687* 	1036170 	1131496 
GP1083167 	1208883 	GP51487 	1203764 
1242529 	1242512 	N/A	N/A
GP1138930 	Service with 1266856* flush actuator and 1269696 flush valve 1269696 	1107584 	1131496  1270755 







Canister
 (Dual-Flush) Toilets

Note: Part numbers that have a “GP” prefix refer to a blister package.
 For example, GP1059291 is the same part as previous part number 1059291 but in a blister package.



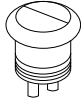
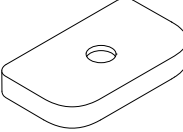
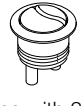

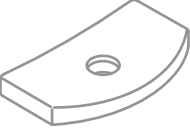
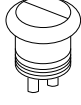
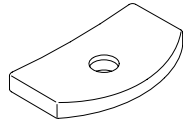
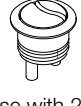

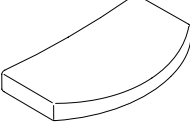
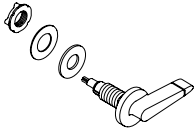
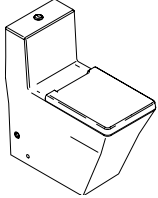
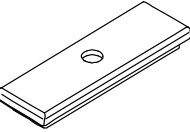
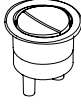



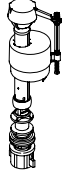



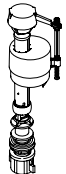

Canister (Dual-Flush) One- and Two-Piece Toilets

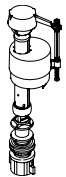
Toilet Details

Canister
(Dual-Flush) Toilets

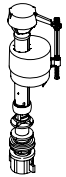
Product Name	Model Number	Tank Cover	Trip Lever/Flush Actuator
Persuade [®] Circ 	K-3753 Tank: K-4442	Discontinued; Service With 1238836* & 1265519*  Hole: 1 ¹ / ₁₆ " (40 mm)	1266856*  For use with 1 ¹ / ₁₆ " hole
	K-3815 Tank: K-7312	1238836*  Hole: 2" (51 mm)	1265519*  For use with 2" hole
Persuade Curv 	K-3723, K-98864 Tank: K-4441	Discontinued; Service With 1217371* & 1265519*  Hole: 1 ¹ / ₁₆ " (40 mm)	1266856*  For use with 1 ¹ / ₁₆ " hole
	K-6355 Tank: K-3569	1217371*  Hole: 2" (51 mm)	1265519*  For use with 2" hole
	K-75790 Tank: K-19042	1261415* 	1208884* LH 1203699* RH 
Rêve [®] 	K-3797	1113930* 	1266856* 

Canister (Dual-Flush) One- and Two-Piece Toilets
 KOHLER® Genuine Parts

Float/Fill Valve	Flush Valve	Tank Gasket	Canister Seal
<p>GP1138930</p> 	<p>Service with 1266856* flush actuator and 1269696 flush valve</p> <hr/> <p>1269696</p> 	<p>1107584</p> 	<p>1131496</p>  <hr/> <p>1270755</p> 
<p>GP1138930</p> 	<p>Service with 1266856* flush actuator and 1269696 flush valve</p> <hr/> <p>1269696</p> 	<p>1107584</p> 	<p>1131496</p>  <hr/> <p>1270755</p> 
<p>GP1138930</p> 	<p>1267749 LH 1267748 RH</p> 	<p>1107584</p> 	<p>1203764</p> 
<p>GP1138930</p> 	<p>1119360</p> 	<p>1118481</p> 	<p>1131496</p> 

Canister
 (Dual-Flush) Toilets

Note: Part numbers that have a "GP" prefix refer to a blister package.
 For example, GP1059291 is the same part as previous part number 1059291 but in a blister package.







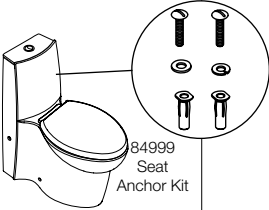
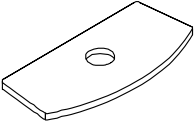
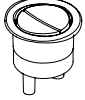
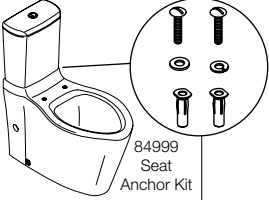
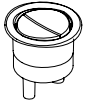
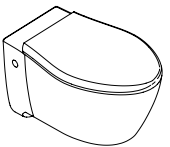
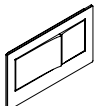
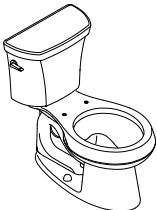
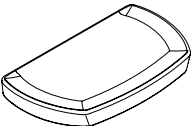
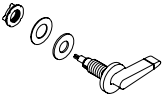

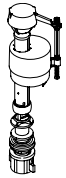

Canister (Dual-Flush) One- and Two-Piece Toilets
Toilet

Toilet Details

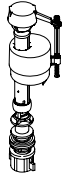
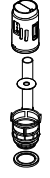
Canister
(Dual-Flush) Toilets

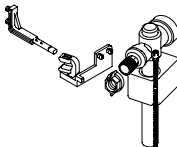
Product Name	Model Number	Tank Cover	Trip Lever/Flush Actuator
Saile® 	K-3564 Artist Editions®: K-14338	1081363* 	1266856* 
Strela® 	K-3598 Tank: K-4742	Discontinued	1266856* 
Veil® 	K-6300, K-6303, K-6304 In-Wall Tank: K-6284, K-18829	N/A	K-6298*  Various flush actuators; visit KOHLER.com/ServiceParts .
Wellworth® 	K-3987, K-3988, K-3989 Tank: K-4458	1138565* 	1208884* LH 1203699* RH 

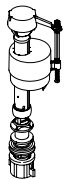
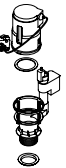
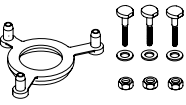
Canister (Dual-Flush) One- and Two-Piece Toilets
 KOHLER® Genuine Parts

Float/Fill Valve	Flush Valve	Tank Gasket	Canister Seal
GP1138930 	1097231 	GP83996 	1131496 
GP1138930 	Use 1269696 & 1266856* 	1107584 	1131496 
1155514 	1155519 	1150348 	N/A
GP1083167 	1208885 LH 1224140 RH 	GP51487 	1203764 

Canister
 (Dual-Flush) Toilets





Note: Part numbers that have a "GP" prefix refer to a blister package.
 For example, GP1059291 is the same part as previous part number 1059291 but in a blister package.

Touchless Toilets



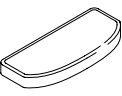
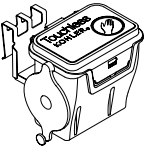

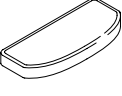
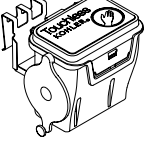

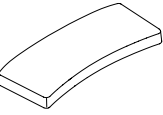
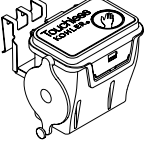
Toilet

Toilet Details

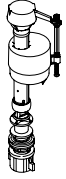
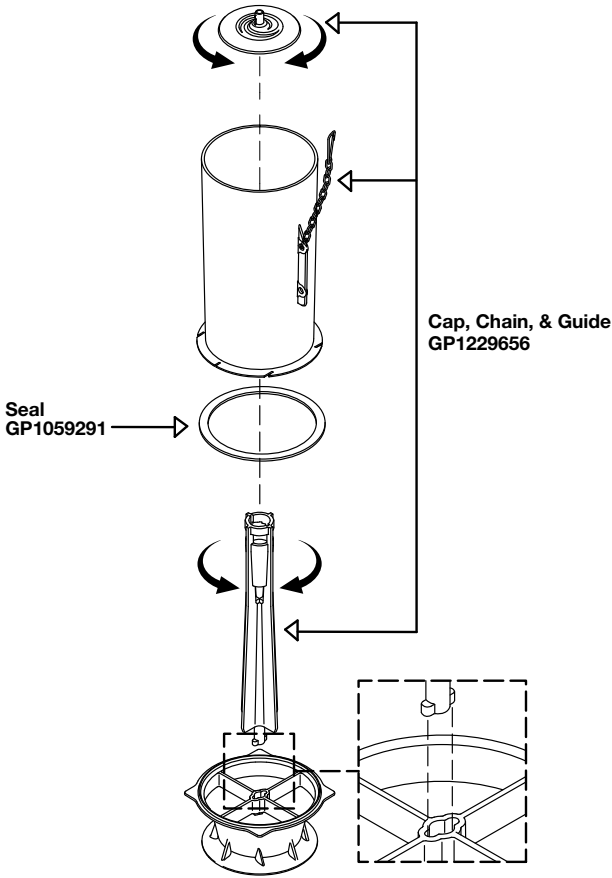
Touchless Toilets

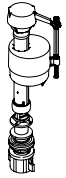
Product Name	Model Number	Tank Cover	Touchless
Cimarron® Elongated 	K-6418 Tank: K-5692	1086929* 	1256315 
Cimarron Round-Front 	K-6419 Tank: K-5693	1086929* 	1256315 
San Souci® 	K-4000	1182368* 	1256315 

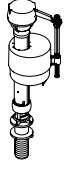
Touchless Toilets KOHLER® Genuine Parts

Float/Fill Valve	Chain/Guide/Seal	Canister	Tank Gasket
<p>GP1083167</p> 	<p>NOTE: The canister should not fail. If leaking occurs, replace seal GP1059291.</p>  <p>Cap, Chain, & Guide GP1229656</p> <p>Seal GP1059291</p> <p>If tabs on guide or cap break, replace with GP1229656</p>	<p>1241992</p>	<p>GP1112256</p> 
<p>GP1138930</p> 		<p>1241991</p>	<p>GP1112256</p> 
<p>1237539</p> 		<p>1227235</p>	<p>GP83996</p> 









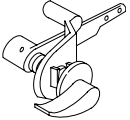
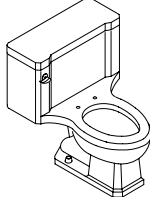

Touchless Toilets

Note: Part numbers that have a "GP" prefix refer to a blister package. For example, GP1059291 is the same part as previous part number 1059291 but in a blister package.

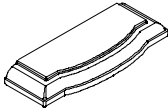
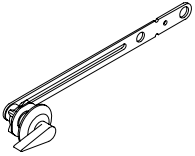
2-Inch Flapper One-Piece Toilets

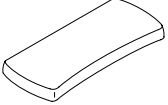

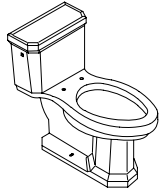
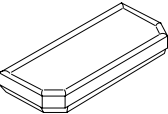







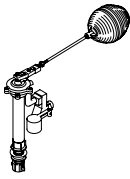
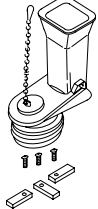
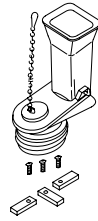
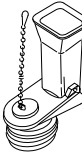
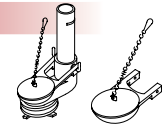
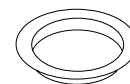

Toilet

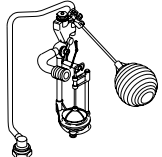
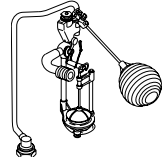
Toilet Details

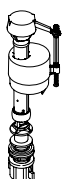
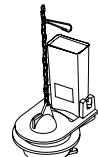
Product Name	Model Number	Tank Cover	Trip Lever
Cabernet™ 	K-3401 K-3408	Discontinued	Various trip levers; visit KOHLER.com/ServiceParts .
Champlain™ 	K-3390	Discontinued	77046* 
Channel™, Bolton™ 	K-3655 K-3670	Discontinued	Discontinued
Devonshire® 	K-3488	1021921* 	1031599* 
Gabrielle™ 	K-3322 Artist Editions®: K-14257, K-14258, K-14286	85407* 	1025329* LH  1025330* RH 
Kathryn® 	K-3324 Artist Editions: K-14268	1006066* 	K-9451*  85085* 

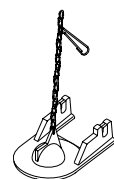
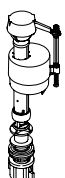
2-Inch Flapper One-Piece Toilets

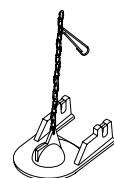
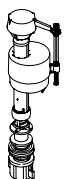
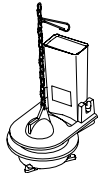
2-Inch Flapper One-Piece Toilets KOHLER® Genuine Parts

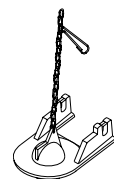
Float/Fill Valve	Flush Valve	Tank Gasket	Flush Ball/Flapper
<p>84499</p>  	<p>83650</p>  <hr/> <p>83094</p>  <p>DISCONTINUED Use 83094</p>  <p>If your toilet currently has this style flush valve and flapper, we recommend they be replaced with flush valve 83094 to prevent potential water damage.</p>	<p>GP53410</p>  <p>GP83888</p> 	<p>GP83064</p>  <p>GP83064</p> 
<p>30669</p> 	<p>30669</p> 	<p>GP53410</p> 	<p>GP88921</p> 
<p>Discontinued</p>	<p>Discontinued</p>	<p>N/A</p>	
<p>GP1138930</p> 	<p>1032640</p> 	<p>GP83996</p> 	<p>GP1078440</p> 
<p>GP1138930</p> 	<p>87998</p> 	<p>GP83996</p> 	<p>GP1078440</p> 
<p>GP1138930</p> 	<p>87998</p> 	<p>GP83996</p> 	<p>GP1078440</p> 







2-Inch Flapper
One-Piece Toilets

Note: Part numbers that have a "GP" prefix refer to a blister package.
For example, GP1059291 is the same part as previous part number 1059291 but in a blister package.

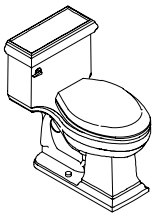
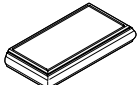
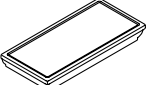
2-Inch Flapper One-Piece Toilets

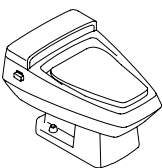
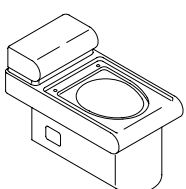
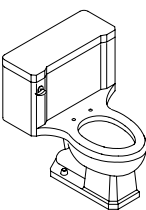

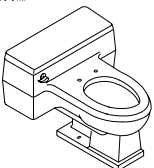



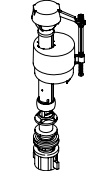
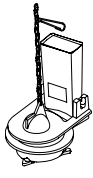
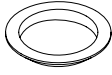
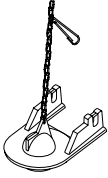
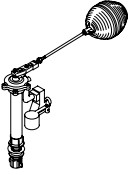
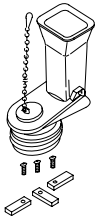
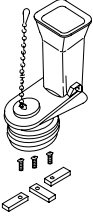
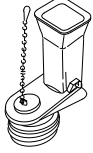
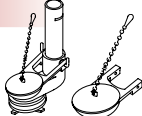
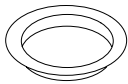

Toilet

Toilet Details

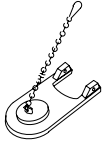
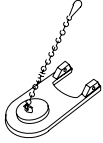
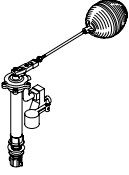
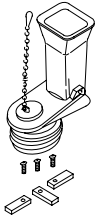
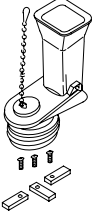
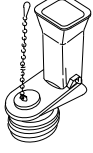
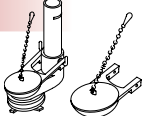
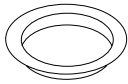
Product Name	Model Number	Tank Cover	Trip Lever
Memoirs [®] 	K-3451 K-3453	1220279* Classic  1220280* Stately 	1039863* 
Palarre [™] 	K-3383	Discontinued	Various trip levers; visit KOHLER.com/ServiceParts .
Pillow Talk [™] 	K-3378	Discontinued	Various trip levers; visit KOHLER.com/ServiceParts .
Placid [™] 	K-3405 K-3600	Discontinued	51170* 
Pompton [™] 	K-3400	Discontinued	51170* 

2-Inch Flapper One-Piece Toilets

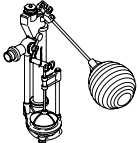
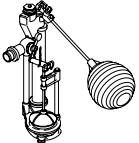
2-Inch Flapper One-Piece Toilets KOHLER® Genuine Parts

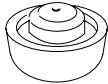
Float/Fill Valve	Flush Valve	Tank Gasket	Flush Ball/Flapper
<p>GP1138930</p> 	<p>87998</p> 	<p>GP83996</p> 	<p>GP1078440</p> 
<p>84499</p>  	<p>83650</p>  <hr style="border-top: 1px dashed black;"/> <p>83094</p>  <p>DISCONTINUED Use 83094</p>  <p>If your toilet currently has this style flush valve and flapper, we recommend they be replaced with flush valve 83094 to prevent potential water damage.</p>	<p>GP53410</p>  <hr style="border-top: 1px dashed black;"/> <p>GP83888</p> 	<p>GP83064</p>  <hr style="border-top: 1px dashed black;"/> <p>GP83064</p> 
<p>84499</p>  	<p>83650</p>  <hr style="border-top: 1px dashed black;"/> <p>83094</p>  <p>DISCONTINUED Use 83094</p>  <p>If your toilet currently has this style flush valve and flapper, we recommend they be replaced with flush valve 83094 to prevent potential water damage.</p>	<p>GP53410</p>  <hr style="border-top: 1px dashed black;"/> <p>GP83888</p> 	<p>GP83064</p>  <hr style="border-top: 1px dashed black;"/> <p>GP83064</p> 
<p>Discontinued</p>	<p>Discontinued</p>	<p>Discontinued</p>	<p>N/A</p>
<p>30668</p> 	<p>30668</p> 	<p>1145626</p> 	<p>GP88921</p> 







2-Inch Flapper
One-Piece Toilets

Note: Part numbers that have a "GP" prefix refer to a blister package.
For example, GP1059291 is the same part as previous part number 1059291 but in a blister package.

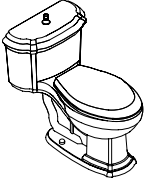
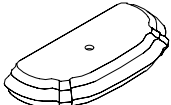
2-Inch Flapper One-Piece Toilets

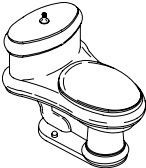
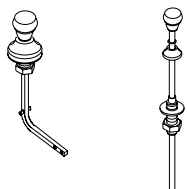
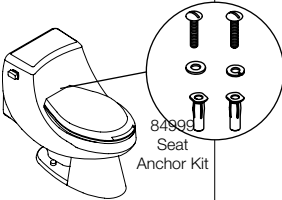

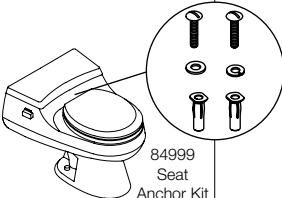
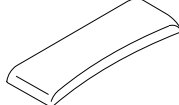

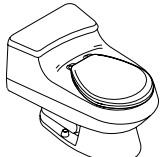





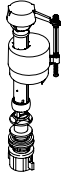
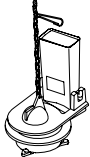

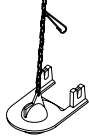
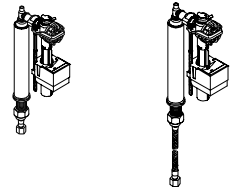





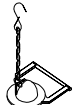
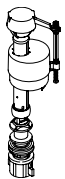

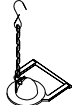
Toilet

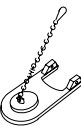
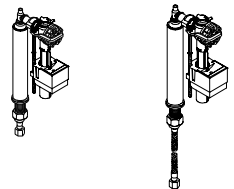
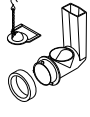
Toilet Details

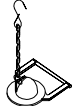
Product Name	Model Number	Tank Cover	Trip Lever
Portrait [®] 	K-3357 Artist Editions [®] : K-14261	89809* 	83725* 
Revival [®] 	K-3360, K-3612 Artist Editions: K-14230	Discontinued	1000833* 83725* 
Rosario™ 	K-3434	Discontinued	78423* 
Rialto [®] 	K-3386 K-3804	84252* 	85114* 
Rialto 	K-3402	Discontinued	Various trip levers; visit KOHLER.com/ServiceParts .

2-Inch Flapper One-Piece Toilets

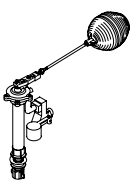
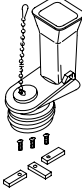
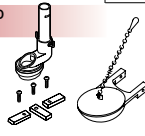
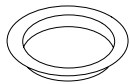
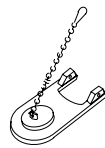
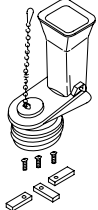
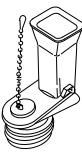
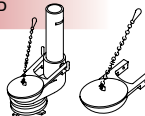
2-Inch Flapper One-Piece Toilets KOHLER® Genuine Parts

Float/Fill Valve	Flush Valve	Tank Gasket	Flush Ball/Flapper
GP1138930 	89827 1060862 	GP83996 	GP89825 
1007490 (Brass Shank) GP1068030 (Plastic Shank) For Rigid Connection For Flexible Connection 	84305 	GP83996 	GP1078440 
	1000837 	84676 	GP84995 
GP1138930 	86972 	84676 	GP84995 
	83093 	GP83888 	GP83064 
GP1068030 (For Rigid Connection) 1068033 (For Flexible Connection) 	1078578 	84676 	GP84995 
	84302 	GP83996 	GP1078440 
84499 	83650  <p>DISCONTINUED Use 83650</p>  <p>If your toilet currently has this style flush valve and flapper, we recommend they be replaced with flush valve 83650 to prevent potential water damage.</p>	GP53410 	GP83064 
	83095  <p>DISCONTINUED Use 83095</p>  <p>If your toilet currently has this style flush valve and flapper, we recommend they be replaced with flush valve 83095 to prevent potential water damage.</p>	GP83888 	GP83064 



**2-Inch Flapper
One-Piece Toilets**

Note: Part numbers that have a "GP" prefix refer to a blister package.
For example, GP1059291 is the same part as previous part number 1059291 but in a blister package.

2-Inch Flapper One-Piece Toilets



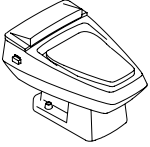
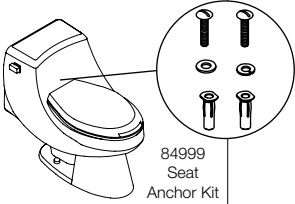







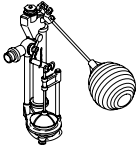
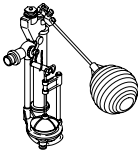

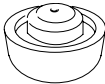
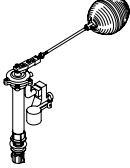
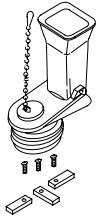
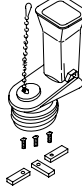

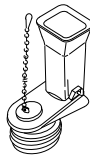
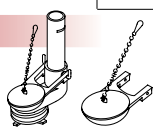

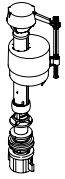
Toilet

Toilet Details

Product Name	Model Number	Tank Cover	Trip Lever
<p>Rochelle™</p> 	<p>K-3385</p>	<p>Discontinued</p>	<p>Various trip levers; visit KOHLER.com/ServiceParts.</p>
<p>San Martine®</p>  <p>84999 Seat Anchor Kit</p>	<p>K-3435 Artist Editions®: K-14289, K-14290, K-14291</p>	<p>Discontinued</p>	<p>Various trip levers; visit KOHLER.com/ServiceParts.</p>
<p>San Miguel™</p> 	<p>K-3406</p>	<p>Discontinued</p>	<p>Various trip levers; visit KOHLER.com/ServiceParts.</p>

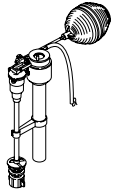
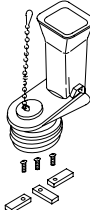
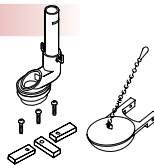
2-Inch Flapper
One-Piece Toilets

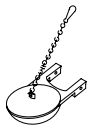
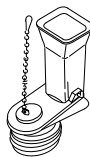
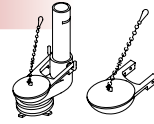
2-Inch Flapper One-Piece Toilets KOHLER® Genuine Parts

Float/Fill Valve	Flush Valve	Tank Gasket	Flush Ball/Flapper
<p>30668 (prior to 1990)</p> 	<p>30668</p> 	<p>1145626</p> 	<p>GP88921</p> 
<p>84499</p>  	<p>83650</p> 	<p>GP53410</p> 	<p>GP83064</p> 
	<p>83094</p>  <p>DISCONTINUED Use 83094</p>  <p>If your toilet currently has this style flush valve and flapper, we recommend they be replaced with flush valve 83094 to prevent potential water damage.</p>	<p>GP83888</p> 	<p>GP83064</p> 
<p>GP1138930</p> 	<p>86972</p> 	<p>84676</p> 	<p>GP84995</p> 
	<p>83093</p> 	<p>GP83888</p> 	<p>GP83064</p> 
<p>30671</p> 	<p>84216</p>  <p>DISCONTINUED Use 84216</p>  <p>If your toilet currently has this style flush valve and flapper, we recommend they be replaced with flush valve 84216 to prevent potential water damage.</p>	<p>GP53410</p> 	<p>GP49114</p> 
	<p>84217</p>  <p>DISCONTINUED Use 84217</p>  <p>If your toilet currently has this style flush valve and flapper, we recommend they be replaced with flush valve 84217 to prevent potential water damage.</p>	<p>GP83888</p> 	<p>GP49114</p> 







2-Inch Flapper
One-Piece Toilets

Note: Part numbers that have a "GP" prefix refer to a blister package.
For example, GP1059291 is the same part as previous part number 1059291 but in a blister package.

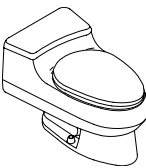
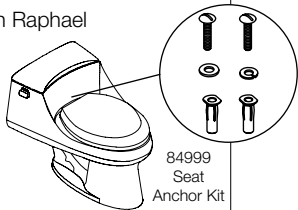
2-Inch Flapper One-Piece Toilets

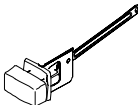
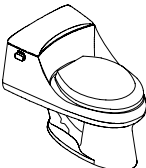
Toilet

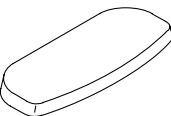









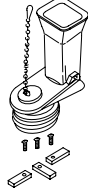



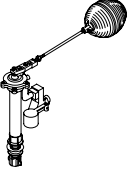
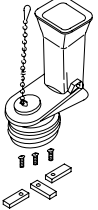
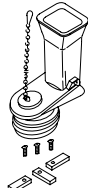







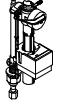
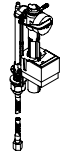
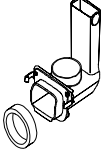

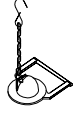
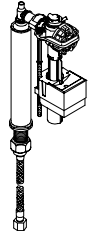
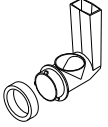
Toilet Details

Product Name	Model Number	Tank Cover	Trip Lever
San Raphael® 	K-3395	Discontinued	Various trip levers; visit KOHLER.com/ServiceParts .
San Raphael 	K-3397	Discontinued	Various trip levers; visit KOHLER.com/ServiceParts .
San Raphael  <p>84999 Seat Anchor Kit</p>	K-3466 K-3467	1010658* 	1013521* 
San Raphael 	K-3384	Discontinued	85114* 
Santa Rosa™ 	K-3323 K-3803 K-11899	88497* 	87115* 

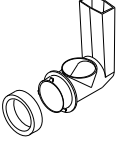
2-Inch Flapper One-Piece Toilets

*Include the color or finish code after the part number when ordering.

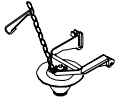
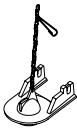
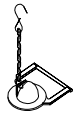
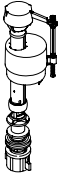
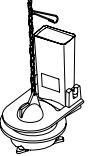
2-Inch Flapper One-Piece Toilets KOHLER® Genuine Parts

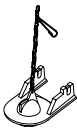
Float/Fill Valve	Flush Valve	Tank Gasket	Flush Ball/Flapper
<p>Discontinued</p>	<p>83650</p>  <p>DISCONTINUED Use 83650</p> 	<p>GP53410</p>  <p>If your toilet currently has this style flush valve and flapper, we recommend they be replaced with flush valve 83650 to prevent potential water damage.</p>	<p>GP83064</p> 
<p>84499</p>  	<p>83650</p>  <p>DISCONTINUED Use 83650</p>  <p>83095</p>  <p>DISCONTINUED Use 83095</p> 	<p>GP53410</p>  <p>If your toilet currently has this style flush valve and flapper, we recommend they be replaced with flush valve 83650 to prevent potential water damage.</p> <p>GP83888</p>  <p>If your toilet currently has this style flush valve and flapper, we recommend they be replaced with flush valve 83095 to prevent potential water damage.</p>	<p>GP83064</p>  <p>GP83064</p> 
<p>1013282 For Rigid Connection</p>  <p>1068031 For Flexible Connection</p> 	<p>1013944</p>  	<p>84676</p> 	<p>GP84995</p> 
<p>GP1068030</p> 	<p>1016123</p>   <p>84284</p>   <p>84996</p>  	<p>84676</p>  <p>GP83996</p>  <p>84676</p> 	<p>1010376</p>  <p>GP1078440</p>  <p>GP84995</p> 
<p>GP1138930</p> 	<p>87998</p> 	<p>GP83996</p> 	<p>GP1078440</p> 





2-Inch Flapper One-Piece Toilets

Note: Part numbers that have a "GP" prefix refer to a blister package. For example, GP1059291 is the same part as previous part number 1059291 but in a blister package.

2-Inch Flapper Two-Piece Toilets

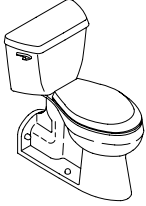

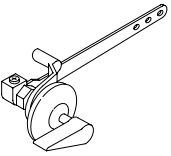
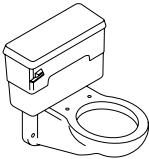
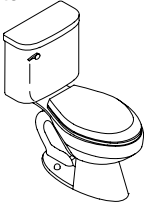
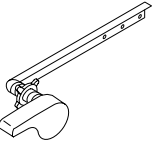







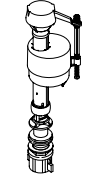
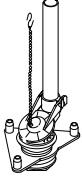

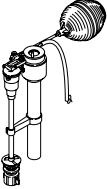
Toilet

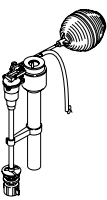
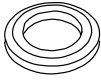
Toilet Details

Product Name	Model Number	Tank Cover	Trip Lever
Barrington® Water-Guard® 	K-3530, K-3535, K-3536 Tank: K-4519	Discontinued	Various trip levers; visit KOHLER.com/ServiceParts .
Bolton Aqua Vent 	K-3450 Tank: K-4505 K-3475 Tank: K-4509	Discontinued	500189* 
Cayuga 	K-3440 Tank: K-4509	Discontinued	Various trip levers; visit KOHLER.com/ServiceParts .
Confidante 	K-3556, K-3557 Tank: K-4456	Discontinued	84625* 
Couture 	K-3471, K-3472 Tank: K-4591 Artist Editions®: K-14213 Tank: K-14215 K-14250 Tank: K-14252 <hr style="border-top: 1px dashed black;"/> K-3477, K-3478, K-3479, K-3480 Tank: K-4605	Discontinued	Various trip levers; visit KOHLER.com/ServiceParts .
Couture Water-Guard 	K-3470 Tank: K-4501 Artist Editions: K-14110 Tank: K-14108 K-14150 Tank: K-14154 K-14128 Tank: K-14129	Discontinued	Various trip levers; visit KOHLER.com/ServiceParts .

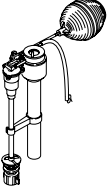
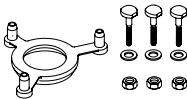
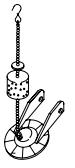
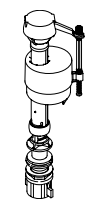
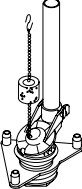
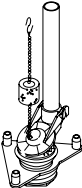
**2-Inch Flapper
Two-Piece Toilets**

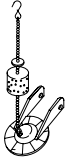
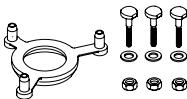
2-Inch Flapper Two-Piece Toilets KOHLER® Genuine Parts

Float/Fill Valve	Flush Valve	Tank Gasket	Flush Ball/Flapper
<p>GP1138930</p> 	<p>85406</p> 	<p>GP51487</p> 	<p>GP87449</p> 
<p>30671</p> 	<p>Discontinued</p>	<p>Discontinued</p>	<p>GP87449</p> 
<p>30671</p> 	<p>Discontinued</p>	<p>51531</p>  <p>GP52050</p> 	<p>GP87449 GP49114</p> <p>OR</p>  
<p>30671</p> 	<p>Discontinued</p>	<p>GP51487</p> 	<p>GP85160</p> 
<p>GP1138930</p> 	<p>1003068</p>  <hr style="border-top: 1px dashed black;"/> <p>1007489</p> 	<p>GP51487</p> 	<p>GP85160</p> 
<p>Discontinued</p>	<p>Discontinued</p>	<p>GP51487</p> 	<p>GP87449</p> 









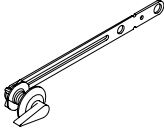

2-Inch Flapper
Two-Piece Toilets

Note: Part numbers that have a "GP" prefix refer to a blister package.
For example, GP1059291 is the same part as previous part number 1059291 but in a blister package.

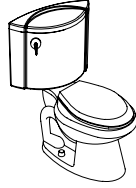
2-Inch Flapper Two-Piece Toilets





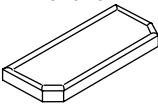





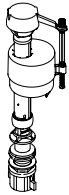
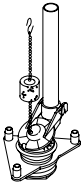

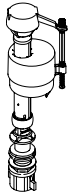
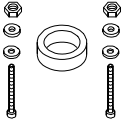
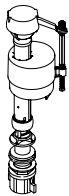
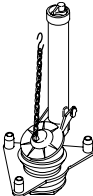
Toilet

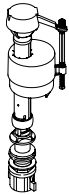
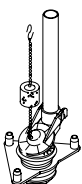
Toilet Details

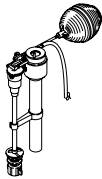
Product Name	Model Number	Tank Cover	Trip Lever
Devonshire® 	K-3457 Tank: K-4619	Discontinued	85086* 
Fleur  	K-3417 Tank: K-4586	Discontinued	Various trip levers; visit KOHLER.com/ServiceParts .
	K-3447 Tank: K-4606	Discontinued	83725* 
Folio 	K-3419, K-3445, K-3448, K-3449, K-3454 Tank: K-4447	Discontinued	Various trip levers; visit KOHLER.com/ServiceParts .
Highline Water-Guard 	K-3527 Tank: K-4518	Discontinued	87115* 
Iron Works® 	K-3456, K-3463 Tank: K-4401	89970* 	Discontinued
Kathryn® 	K-3484 Tank: K-4403	1015781* 	Discontinued

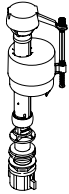
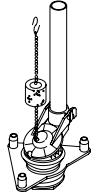
2-Inch Flapper Two-Piece Toilets

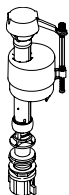
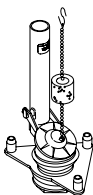
2-Inch Flapper Two-Piece Toilets KOHLER® Genuine Parts

Float/Fill Valve	Flush Valve	Tank Gasket	Flush Ball/Flapper
GP1138930 	84665 	GP51487 	GP85160 
GP1138930 	Discontinued	84539 	N/A
GP1138930 	85302 	GP51487 	GP87449 
GP1138930 	1004808 	GP51487 	GP85160 
30671 	Discontinued	GP51487 	GP49114 
GP1138930 	1003068 	GP51487 	GP85160 
GP1138930 	1022551 	GP51487 	GP85160 











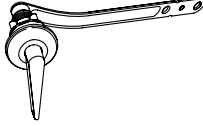

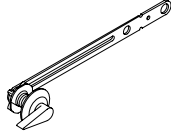
2-Inch Flapper
Two-Piece Toilets

Note: Part numbers that have a "GP" prefix refer to a blister package.
For example, GP1059291 is the same part as previous part number 1059291 but in a blister package.

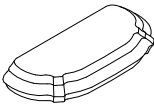
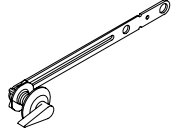
2-Inch Flapper Two-Piece Toilets

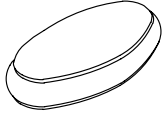



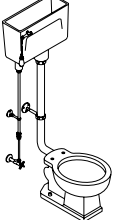





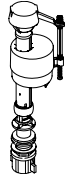
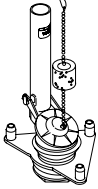

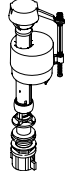
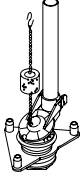
Toilet

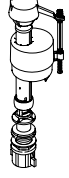
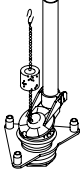
Toilet Details

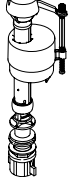
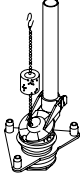
Product Name	Model Number	Tank Cover	Trip Lever
Leighton® 	K-3486, K-3651 Tank: K-4628	Discontinued	1022562* 
Memoirs® 	<p style="text-align: center;">Classic</p> K-3429, K-3452 Tank: K-4454 <p style="text-align: center;">Stately</p> K-3439, K-3462 Tank: K-4464	Discontinued	85086* 
Pinoir® 	K-3465, K-3482, K-3483, K-3485 Tank: K-4609	Discontinued	85085* LH 1007913* RH 
Portrait® Lite 	K-3591, K-3490, K-3491 Tank: K-4590, K-4807 <p style="text-align: center;">Artist Editions®:</p> K-14178 Tank: K-14179 K-14247 Tank: K-14249	80625* 	85086* 
Revival® 	K-3555 Tank: K-3613 <p style="text-align: center;">K-3455</p> Tank: K-4445 <p style="text-align: center;">Artist Editions:</p> K-14239 Tank: K-14241	83834* 	83725* 
Serif® 	K-3444, K-3461, K-3464, K-3468 Tank: K-4608	Discontinued	83725* 
Vintage® 	K-3410 Tank: K-4515 <hr style="border-top: 1px dashed black;"/> K-3411, K-3412 Tank: K-4516	Discontinued	Discontinued

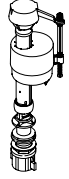
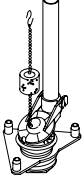
**2-Inch Flapper
Two-Piece Toilets**

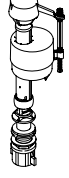
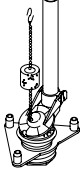
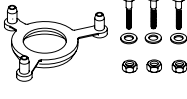
2-Inch Flapper Two-Piece Toilets KOHLER® Genuine Parts

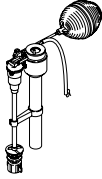
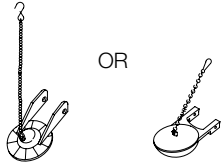
Float/Fill Valve	Flush Valve	Tank Gasket	Flush Ball/Flapper
GP1138930 	1022551 	GP51487 	GP85160 
GP1138930 	1042831 	GP51487 	GP85160 
GP1138930 	1015139 	GP51487 	GP87449 
GP1138930 	87373 (1.6 GPF) 	GP51487 	GP85160 
GP1138930 	85159 	GP51487 	GP85160 
GP1138930 	1004808 	GP51487 	GP85160 
76171 	Discontinued	Discontinued	GP87449 GP49114 ? OR 









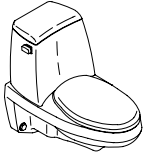
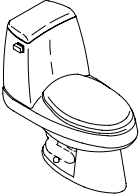

2-Inch Flapper
Two-Piece Toilets

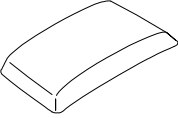
Note: Part numbers that have a "GP" prefix refer to a blister package.
For example, GP1059291 is the same part as previous part number 1059291 but in a blister package.

2-Inch Flapper Two-Piece Toilets

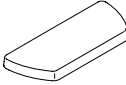

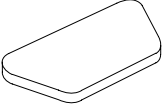







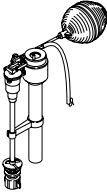

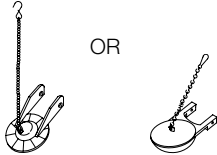
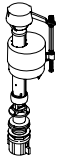
Toilet

Toilet Details

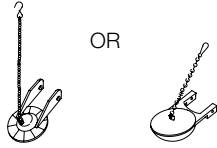
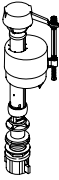
Product Name	Model Number	Tank Cover	Trip Lever
Wellesley Water-Guard® 	K-3441 Tank: K-4209	Discontinued	Various trip levers; visit KOHLER.com/ServiceParts .
Wellington  	K-3446 Tank: K-4646 Artist Editions®: K-14210 Tank: K-14212	83584* 	Various trip levers; visit KOHLER.com/ServiceParts .
	K-3415 Tank: K-4504 Artist Editions: K-14133 Tank: K-14137 K-14143 Tank: K-14147 K-14076 Tank: K-14078	Discontinued	Various trip levers; visit KOHLER.com/ServiceParts .
Wellworth®, Highline® 	K-3433, K-3438 Tank: K-4621	84095* 	30324* 
	K-11450, K-11470, K-3422, K-3423, K-3432, K-3427, K-3481 Tank: K-4620	84591* 	87114* 
Wellworth 	K-3407, K-3420, K-3421, K-3428 Tank: K-4512 K-3414 Tank: K-4597	82869* (7 ³ / ₄ " Discontinued 80625* (10") 	Various trip levers; visit KOHLER.com/ServiceParts .
Wellworth Water-Guard, Northline 	K-3520, K-3521 Tank: K-4519	Discontinued	Various trip levers; visit KOHLER.com/ServiceParts .

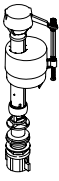
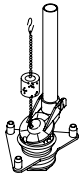
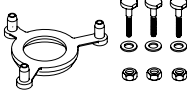
2-Inch Flapper Two-Piece Toilets

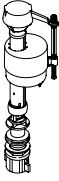
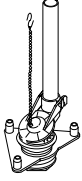
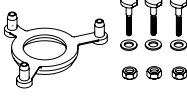
2-Inch Flapper Two-Piece Toilets KOHLER® Genuine Parts

Float/Fill Valve	Flush Valve	Tank Gasket	Flush Ball/Flapper
<p>30652</p> 	<p>Discontinued</p>	<p>GP51487</p> 	<p>GP87449 GP49114</p> <p>OR</p> 
<p>GP1138930</p> 	<p>Discontinued</p>	<p>GP51487</p> 	<p>GP87449</p> 
<p>30652</p> 	<p>Discontinued</p>	<p>GP51487</p> 	<p>GP87449 GP49114</p> <p>OR</p> 
<p>GP1138930</p> 	<p>Discontinued</p>	<p>GP51487</p> 	<p>GP85160</p> 
<p>GP1138930</p> 	<p>1003068</p> 	<p>GP51487</p> 	<p>GP85160</p> 
<p>GP1138930</p> 	<p>85406</p> 	<p>GP51487</p> 	<p>GP87449</p> 

2-Inch Flapper
Two-Piece Toilets

Note: Part numbers that have a "GP" prefix refer to a blister package.
For example, GP1059291 is the same part as previous part number 1059291 but in a blister package.

2-Inch Flapper Two-Piece Toilets

Toilet



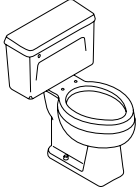
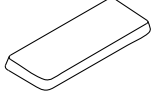
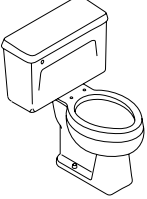
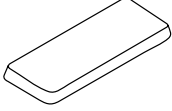



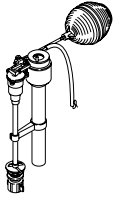

Toilet Details

Product Name	Model Number	Tank Cover	Trip Lever
Wellworth®, Highline®, Tylon, Barlow 	K-3510, K-3512, K-3514 Tank: K-4524	81187* 	Various trip levers; visit KOHLER.com/ServiceParts .
Wellworth Water-Guard® 	K-3500, K-3502, K-3504 Tank: K-4509	81509* 	Various trip levers; visit KOHLER.com/ServiceParts .

NOTES:

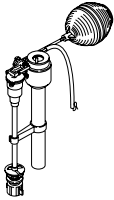

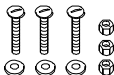
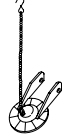



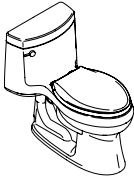
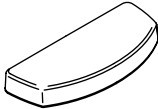
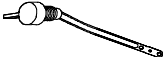
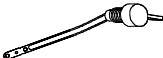

2-Inch Flapper
Two-Piece Toilets

2-Inch Flapper Two-Piece Toilets KOHLER® Genuine Parts

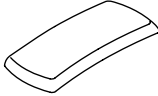
Float/Fill Valve	Flush Valve	Tank Gasket	Flush Ball/Flapper
<p style="text-align: center;">30671</p> 	N/A	<p style="text-align: center;">51531</p>  <p style="text-align: center;">GP52050</p> 	<p style="text-align: center;">GP87449 GP49114</p> <p style="text-align: center;">OR</p>  
<p style="text-align: center;">30672</p> 	N/A	<p style="text-align: center;">51531</p>  <p style="text-align: center;">GP52050</p> 	<p style="text-align: center;">GP87449 GP49114</p> <p style="text-align: center;">OR</p>  

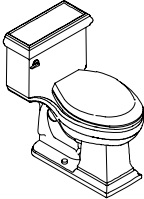
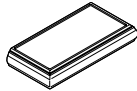
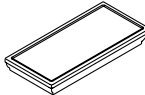
NOTES:

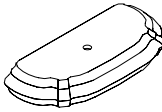

Note: Part numbers that have a “GP” prefix refer to a blister package.
For example, GP1059291 is the same part as previous part number 1059291 but in a blister package.

Product Name	Model Number	Tank Cover	Trip Lever
Cimarron® 	K-3489 K-3802 K-11889	1036367* 	1034693* LH  1036058* RH 
Gabrielle™ 	K-3513, K-3608 Artist Editions®: K-14343, K-14344, K-14345, K-14346	85407* 	1068627* LH  1080378* RH 
Memoirs® 	Classic K-3451 Stately K-3453	1220279* Classic  1220280* Stately 	1039863* 
Portrait® 	K-3506	89809* 	83725* 

NOTES:

3/4-Inch Flapper
One-Piece Toilets

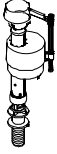
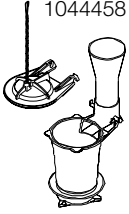
3/4-Inch Flapper One-Piece Toilets
 KOHLER® Genuine Parts

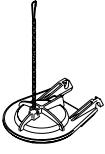
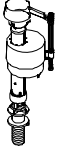
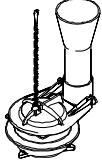
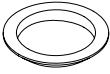
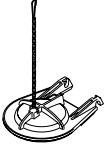
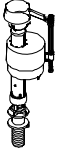
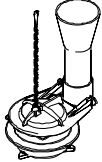
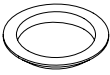
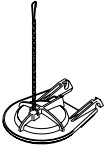
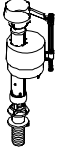
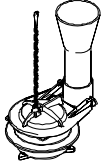
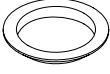
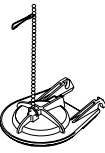
Float/Fill Valve	Flush Valve	Tank Gasket	Flush Ball/Flapper
GP1083167 	1044458 	GP83996 	GP1039444 
GP1083167 	1068622 	GP83996 	GP1067183 
GP1083167 	1039861 	GP83996 	GP1039444 
GP1083167 	1060862 	GP83996 	GP1060740 











NOTES:

Note: Part numbers that have a “GP” prefix refer to a blister package.
 For example, GP1059291 is the same part as previous part number 1059291 but in a blister package.

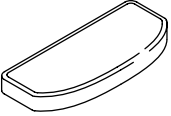
3/4-Inch Flapper Two-Piece Toilets

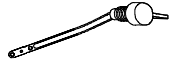
Toilet

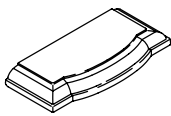
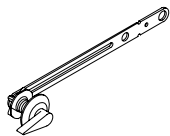

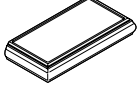
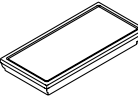
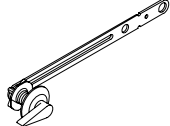







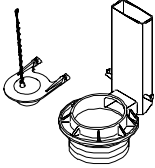

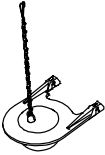

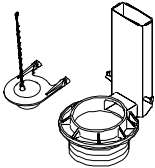
Toilet Details

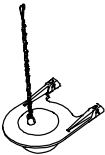
Product Name	Model Number	Tank Cover	Trip Lever
Bancroft® 	K-3487 Tank: K-4633	1033723* 	1042212* 
Cimarron® 	1.28 GPF K-3496-HE Tank: K-4634-HE 1.6 GPF K-3496, K-3497, K-3499, K-11465 Tank: K-4634	1015867* 	1034693* LH  1036058* RH 
Devonshire® 	K-3503 Tank: K-4708	1044820* 	85086* 
Memoirs® 	Classic K-3532, K-3542 Tank: K-4485 K-11461, K-3509, K-3515 Tank: K-4491 Stately K-11460, K-3511, K-3526 Tank: K-4492 K-3533, K-3548 Tank: K-4473	1052861* Classic  1052862* Stately 	85086* 

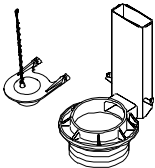
3/4-Inch Flapper Two-Piece Toilets

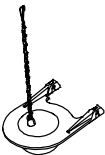
NOTES:

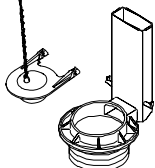
3/4-Inch Flapper Two-Piece Toilets KOHLER® Genuine Parts

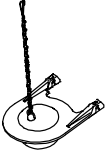
Float/Fill Valve	Flush Valve	Tank Gasket	Flush Ball/Flapper
<p>GP1083167</p> 	<p>1042499</p> 	<p>GP1018165-F 1024390</p> 	<p>GP1078441</p> 
<p>GP1083167</p> 	<p>1024385</p> 	<p>GP1018165-F 1024390</p> 	<p>GP1078441</p> 
<p>GP1083167</p> 	<p>1042499</p> 	<p>GP1018165-F 1024390</p> 	<p>GP1078441</p> 
<p>GP1083167</p> 	<p>1060218</p> 	<p>GP1018165-F 1024390</p> 	<p>GP1078441</p> 



3/4-Inch Flapper
Two-Piece Toilets

NOTES:



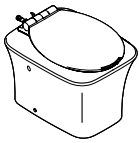
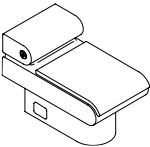
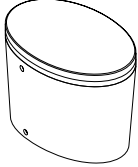
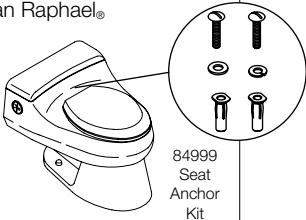
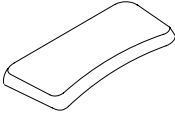

Note: Part numbers that have a "GP" prefix refer to a blister package.
For example, GP1059291 is the same part as previous part number 1059291 but in a blister package.

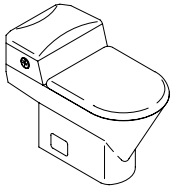
Toilet

Toilet Details

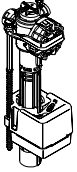
Product Name	Model Number	Tank Cover	Trip Lever
Fountainhead 	K-3524	N/A	N/A
Call Technical Support 800-4KOHLER			
Pillow Talk 	K-3379	Discontinued	Various trip levers; visit KOHLER.com/ServiceParts .
Call Technical Support 800-4KOHLER			
Purist® Hatbox 	K-3492	N/A	N/A
Call Technical Support 800-4KOHLER			
San Raphael®  <p>84999 Seat Anchor Kit</p>	K-3607 K-3393 K-3398	1055954* 	81996* 
Call Technical Support 800-4KOHLER			
Trocadero 	K-3437	N/A	Various trip levers; visit KOHLER.com/ServiceParts .
Call Technical Support 800-4KOHLER			

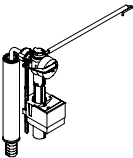
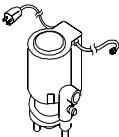
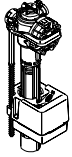
Power Lite® One-Piece Toilets
 KOHLER® Genuine Parts

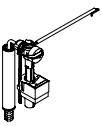
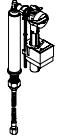
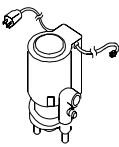
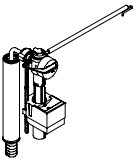
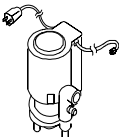
Float/Fill Valve	Flush Valve	Seat	
1097551 	1044465 (Pump) 	1057635*	
Call Technical Support 800-4KOHLER			
1007489 	84153 (Pump) 	74929*	
Call Technical Support 800-4KOHLER			
1043213 	1044465 (Pump) 	1022679*	
Call Technical Support 800-4KOHLER			
1007489 For Rigid Connection 	1068034 For Flexible Connection 	84153 (Pump) 	Various seats, visit KOHLER.com/ServiceParts
Call Technical Support 800-4KOHLER			
1007489 	84153 (Pump) 	Discontinued	
Call Technical Support 800-4KOHLER			

Power Lite
 One-Piece Toilets

Intelligent Toilets

Toilet

Toilet Details

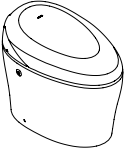
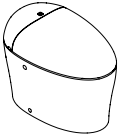
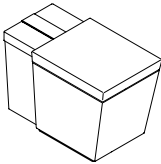
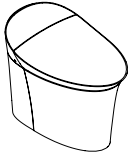
Product Name	Model Number	Tank Cover	Trip Lever
Karing®  	K-4026	N/A	1188925 (Remote Assembly)
	K-77780		1283749 (Remote Assembly)
Call Technical Support 800-4KOHLER			
Numi® 	K-3900	N/A	1183987* (User Interface)
	K-3901	N/A	N/A (User Interface)
Call Technical Support 800-4KOHLER			
Veil® 	K-5401	N/A	1235953 (Remote Assembly)
Call Technical Support 800-4KOHLER			

NOTES:











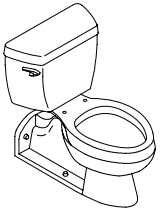
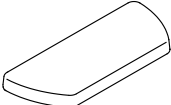

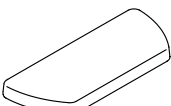

Intelligent Toilets
KOHLER® Genuine Parts

Float/Fill Valve	Flush Valve	Seat
N/A	N/A	N/A
Call Technical Support 800-4KOHLER		
N/A	N/A	Discontinued
N/A	N/A	1214139*
Call Technical Support 800-4KOHLER		
N/A	N/A	K-6299
Call Technical Support 800-4KOHLER		

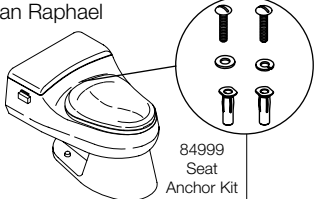
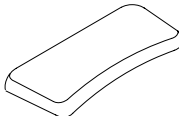
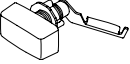
NOTES:

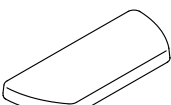
Pressure Lite® One- and Two-Piece Toilets

Toilet Details

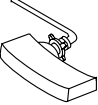
Product Name	Model Number	Tank Cover	Trip Lever
Barrington™ 	K-3652 Tank: K-4484	1036375* 	1045276* LH 
			1045277* RH 
Call Technical Support 800-4KOHLER			
Highline® 	K-3493, K-3554 Tank: K-4645 K-3519, K-3531 Tank: K-4484	1036375* 	1045276* LH 
			1045277* RH 
Call Technical Support 800-4KOHLER			
Rialto® 	K-3404	Discontinued	Discontinued
			Call Technical Support 800-4KOHLER
San Raphael® 	K-3394	Discontinued	Discontinued
			Call Technical Support 800-4KOHLER
San Raphael  <p style="font-size: small;">84999 Seat Anchor Kit</p>	K-3393 K-3597 K-3607	1055954* 	1089001* 
			Call Technical Support 800-4KOHLER
Wellworth® 	K-3505 Tank: K-4645	1036375* 	1045276* LH 
			1045277* RH 
Call Technical Support 800-4KOHLER			
Wellworth, Highline, Barrington 	K-3458, K-3544, K-3546 Tank: K-4470	Discontinued	84874* 
			Call Technical Support 800-4KOHLER

Pressure Lite® One- and Two-Piece Toilets
KOHLER® Genuine Parts

Float/Fill Valve	Flush Valve	Seat	Flush Ball/Flapper
N/A	N/A	84460  GP52050 	N/A
Call Technical Support 800-4KOHLER			
N/A	N/A	GP51487  	N/A
Call Technical Support 800-4KOHLER			
N/A	N/A	N/A	N/A
Call Technical Support 800-4KOHLER			
N/A	N/A	N/A	N/A
Call Technical Support 800-4KOHLER			
N/A	N/A	1104621 	N/A
Call Technical Support 800-4KOHLER			
N/A	N/A	84460  GP52050 	N/A
Call Technical Support 800-4KOHLER			
N/A	N/A	1037307  GP52050 	N/A
Call Technical Support 800-4KOHLER			











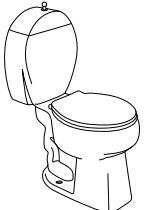

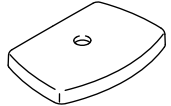
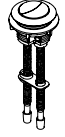

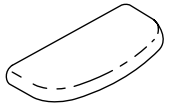
Pressure Lite
 One- and Two-Piece Toilets

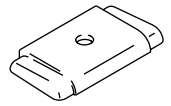
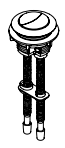
Note: Part numbers that have a "GP" prefix refer to a blister package.
 For example, GP1059291 is the same part as previous part number 1059291 but in a blister package.

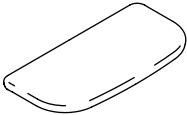
Toilet

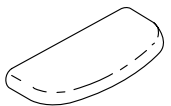









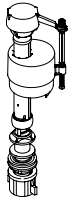

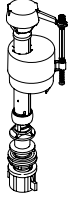

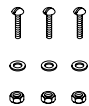

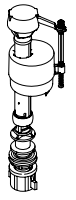
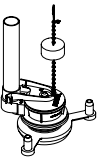

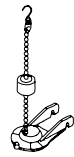

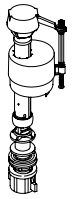

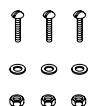
Toilet Details

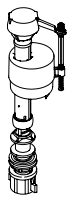
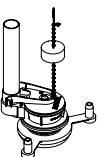
STERLING Toilets

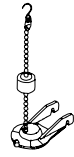
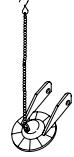
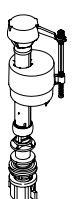
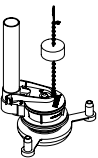
Product Name	Model Number	Tank Cover	Trip Lever																				
Cordova 	402020 402220 Tank: 404520	Discontinued	Discontinued																				
Karsten® 	402025 402087 402028 Tank: 402023	1040340* 	1266856* 																				
Riverton™ 	<table border="0"> <tr> <td>1.28 GPF</td> <td>1.6 GPF</td> </tr> <tr> <td>402083</td> <td>402502</td> </tr> <tr> <td>402084</td> <td>402522</td> </tr> <tr> <td>402085</td> <td>402532</td> </tr> <tr> <td>404701</td> <td></td> </tr> <tr> <td>Tank: 404552</td> <td>Tank: 404522</td> </tr> </table>	1.28 GPF	1.6 GPF	402083	402502	402084	402522	402085	402532	404701		Tank: 404552	Tank: 404522	1169890* (1.28 GPF) 84624* (1.6 GPF) 	84625-CP (Chrome) 1166878-0 (White) 85086-VF (Brass) 								
1.28 GPF	1.6 GPF																						
402083	402502																						
402084	402522																						
402085	402532																						
404701																							
Tank: 404552	Tank: 404522																						
Rockton® 	402024 402027 402088 Tank: 402022	1045794* 	1266856* 																				
Stinson® 	<table border="0"> <tr> <td>1.28 GPF</td> <td>1.6 GPF</td> </tr> <tr> <td>402076</td> <td>402075</td> </tr> <tr> <td>402077</td> <td>402375</td> </tr> <tr> <td>404702</td> <td>Tank: 402071</td> </tr> <tr> <td>404704</td> <td></td> </tr> <tr> <td>Tank: 402091</td> <td></td> </tr> </table>	1.28 GPF	1.6 GPF	402076	402075	402077	402375	404702	Tank: 402071	404704		Tank: 402091		1068490* 	1185068* 								
1.28 GPF	1.6 GPF																						
402076	402075																						
402077	402375																						
404702	Tank: 402071																						
404704																							
Tank: 402091																							
Windham™ 	<table border="0"> <tr> <td>1.28 GPF</td> <td>1.6 GPF</td> </tr> <tr> <td>402080</td> <td>402015</td> </tr> <tr> <td>402081</td> <td>402215</td> </tr> <tr> <td>402082</td> <td>402315</td> </tr> <tr> <td>404700</td> <td>Tank: 404515</td> </tr> <tr> <td>Tank: 404555</td> <td></td> </tr> <tr> <td>402078</td> <td>402014</td> </tr> <tr> <td>402079</td> <td>402214</td> </tr> <tr> <td>Tank: 404544</td> <td>402315</td> </tr> <tr> <td></td> <td>Tank: 404514</td> </tr> </table>	1.28 GPF	1.6 GPF	402080	402015	402081	402215	402082	402315	404700	Tank: 404515	Tank: 404555		402078	402014	402079	402214	Tank: 404544	402315		Tank: 404514	84537* 	84625-CP (Chrome) 1166878-0 (White) 85086-VF (Brass) 
1.28 GPF	1.6 GPF																						
402080	402015																						
402081	402215																						
402082	402315																						
404700	Tank: 404515																						
Tank: 404555																							
402078	402014																						
402079	402214																						
Tank: 404544	402315																						
	Tank: 404514																						
Windham 	<table border="0"> <tr> <td>1.28 GPF</td> <td>1.6 GPF</td> </tr> <tr> <td>403080</td> <td>402211</td> </tr> <tr> <td>403081</td> <td>402212</td> </tr> <tr> <td>403082</td> <td>402213</td> </tr> <tr> <td>404705</td> <td>Tank: 402093</td> </tr> <tr> <td>Tank: 404551</td> <td></td> </tr> </table>	1.28 GPF	1.6 GPF	403080	402211	403081	402212	403082	402213	404705	Tank: 402093	Tank: 404551		1203861* 	84625-CP (Chrome) 1166878-0 (White) 85086-VF (Brass) 								
1.28 GPF	1.6 GPF																						
403080	402211																						
403081	402212																						
403082	402213																						
404705	Tank: 402093																						
Tank: 404551																							

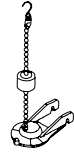
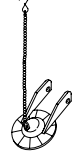
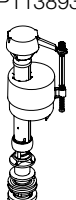
STERLING® Toilets
 KOHLER® Genuine Parts

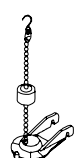
STERLING Toilets

Float/Fill Valve	Flush Valve	Tank Gasket	Flush Ball/Flapper
GP1138930 	N/A	GP51487 	GP87449 1.6 GPF 
GP1138930 	1072320 	1032265  30419 	1131496 
GP1138930 	1110262 (1.28 GPF) 84910 (1.6 GPF) 	GP51487 	GP1105825 1.28 GPF OR GP87449 1.6 GPF  
GP1138930 	1072320 	1032265  30419 	1131496 
GP1138930 	1110262 (1.28 GPF) 84910 (1.6 GPF) 	GP51487 	GP1105825 1.28 GPF OR GP87449 1.6 GPF  
GP1138930 	1110262 (1.28 GPF) 85073 (1.6 GPF) 	GP51487 	GP1105825 1.28 GPF OR GP87449 1.6 GPF  
GP1138930 	1212845 (1.28 GPF) 1284420 (1.6 GPF) 	GP51487 	GP1105825 1.28 GPF OR GP87449 1.6 GPF  

Note: Part numbers that have a "GP" prefix refer to a blister package.
 For example, GP1059291 is the same part as previous part number 1059291 but in a blister package.

[KOHLER.com/ServiceParts](https://www.kohler.com/ServiceParts)

GENUINE PARTS
STERLING[®]
A **KOHLER** COMPANY

KOHLER[®]
GENUINE PARTS

Form 10-1099-0420
© 2020 by Kohler Co.
Kohler, Wisconsin 53044
Printed in U.S.A.
1-800-4-KOHLER
(1-800-456-4537)